



Stakeholder update

Jason Yencopal to: Audie Huber, Carolyn Templeton, Carl Stiff, Colleen Fagan, GRIFFIN Dennis, Emily Carter, Fred Warner, Gary Miller, Ken
09/03/2010 02:13 PM
Cc: Heidi Martin, Jason Yencopal

From: Jason Yencopal/Baker County
To: "Audie Huber" <Audiehuber@ctuir.com>, "Carolyn Templeton" <Carolyn.Templeton@ferc.gov>, "Carl Stiff" <cbstiff@wildblue.net>, "Colleen Fagan" <Colleen.E.Fagan@state.or.us>, "GRIFFIN Dennis" <Dennis.Griffin@state.or.us>, "Emily
Cc: Heidi Martin/Baker County@Baker County, Jason Yencopal/Baker County@Baker County

Dear Stakeholders,

Baker County proposed a site visit as mentioned in our August 18, 2010 update letter. For this visit I would like your feedback on the water level or approximate CFS flow to view the area. Now until October the flow will be greater than 25 cfs, making it difficult to examine the sub straight. During October the release will be less than 25 cfs. I have recently discussed the two compliance points with ODF&W. Their stance is that, no evidence has been provided for them to determine that there is no spawning in the reach. The County based its decision for two compliance points due to lack of sub straight for spawning from an invertebrate study. ODF&W currently does not have any sub straight studies or spawning documentation for this reach.

As Baker County works on its proposed PM&E measures, we would like to ask for your assistance, especially concerning our decision not to screen the intake. From the work session it was my understanding that most of the agencies already had some plans in mind with cost estimates that they would like to see done. In order that we can incorporate these into a master plan please send me all available information on these plans and your ideas.

Sincerely,
Jason Yencopal



RE: Stakeholder update

DEVITO Paul to: jyencopal, Audie Huber, Carolyn Templeton, Carl Stiff, FAGAN Colleen E, GRIFFIN Dennis, Emily Carter, Fred Warner, Gary Miller, Ken
08/18/2010 04:19 PM
Cc: hmartin

From: "DEVITO Paul" <DEVITO.Paul@deq.state.or.us>
To: <jyencopal@bakercounty.org>, "Audie Huber" <Audiehuber@ctuir.com>, "Carolyn Templeton" <Carolyn.Templeton@ferc.gov>, "Carl Stiff" <cbstiff@wildblue.net>, "FAGAN Colleen E" <Colleen.E.Fagan@state.or.us>, "GRIFFIN Dennis" <Dennis.Griffin@state.or.us>, "Emily
Cc: <hmartin@bakercounty.org>

Hello Jason,

I'll forward the letter update on to Steve Kirk of this office. Please see attached email that I sent over Monday indicating that Steve is my replacement as the DEQ contact for Mason Dam.

Thanks, Paul

Paul A. DeVito
Environmental Engineer
Oregon Department of Environmental Quality
475 NE Bellevue, Suite 110
Bend, Oregon 97701
Ph: 541-633-2029 FAX: 541-388-8283

▪ Reduce. Reuse. Recycle. Please consider the environment before printing this email..

-----Original Message-----

From: jyencopal@bakercounty.org [mailto:jyencopal@bakercounty.org]
Sent: Wednesday, August 18, 2010 3:43 PM
To: Audie Huber; Carolyn Templeton; Carl Stiff; FAGAN Colleen E; GRIFFIN Dennis; Emily Carter; Fred Warner; Gary Miller; Ken Anderson; Kenneth Hogan; GRAINEY Mary S; Mike Gerdes; Micheal Hall; Randy Joseph; DEVITO Paul; Quentin Lawson; LUSK Rick M; Robert Ross; Shawn Steinmetz; Susan Rosebrough; STAHL Thomas; Timothy Welch; GRIFFIN Dennis; Joseph Hassell; Carl Merkle; lgecy@ecowest-inc.com; ted@tsorenson.net; gsense@cableone.net
Cc: hmartin@bakercounty.org; jyencopal@bakercounty.org
Subject: Stakeholder update

Stakeholders,

Attached is a letter updated you on the County's progress. We look forward to continue working with you through this process. If you have any questions, please feel free to get a hold of me.

Thank you,
Jason Yencopal

(See attached file: Stakeholder update letter 8_18_2010.pdf)

Message from "DEVITO Paul" <DEVITO.Paul@deq.state.or.us> on Mon, 16 Aug 2010 14:11:40 -----
----- 0700-

<jyencopal@bakercounty.org> :To
<KIRK Steve" <KIRK.Steve@deq.state.or.us" :cc

Hello Jason,

Just wanted to drop you a quick note to let you know of the new ODEQ 401 contact for Mason Dam. Steve Kirk, copied here, has been with ODEQ's Bend Office water quality program since 1998. I've briefed Steve on the project. Please feel free to contact Steve directly with questions or concerns relative to the 401 process for Baker County's proposed Mason Dam hydro project.

Steve's contact information:
Kirk.steve@deq.state.or.us
Ph. (541)633-2023

Thanks, Paul



Stakeholder update

Jason Yencopal to: Audie Huber, Carolyn Templeton, Carl Stiff,
Colleen Fagan, GRIFFIN Dennis, Emily
Carter, Fred Warner, Gary Miller, Ken
Cc: Heidi Martin, Jason Yencopal

08/18/2010 03:42 PM

From: Jason Yencopal/Baker County
To: "Audie Huber" <Audiehuber@ctuir.com>, "Carolyn Templeton"
<Carolyn.Templeton@ferc.gov>, "Carl Stiff" <cbstiff@wildblue.net>, "Colleen Fagan"
<Colleen.E.Fagan@state.or.us>, "GRIFFIN Dennis" <Dennis.Griffin@state.or.us>, "Emily
Cc: Heidi Martin/Baker County@Baker County, Jason Yencopal/Baker County@Baker County

Stakeholders,

Attached is a letter updated you on the County's progress. We look forward to continue working with you through this process. If you have any questions, please feel free to get a hold of me.

Thank you,
Jason Yencopal



Stakeholder update letter 8_18_2010.pdf

August 18, 2010

Subject: Mason Dam Hydroelectric Project Update

Dear Stakeholders:

The 20-May-2010 meeting in Baker City focused on three issues:

1. Transmission line route
2. Dissolved oxygen in the Powder River below Mason Dam
3. Fish entrainment and mortality through Mason Dam

As we move toward developing our final license proposal, we wish to update you on the current project plans with regard to these issues. These plans are in accordance with the discussions at the May meeting.

Transmission Line Route

The preferred transmission line route has been changed from an underground line buried alongside Black Mountain Road to an over head line near the same route. The change is due to concerns about the cost of construction and maintenance of an underground line. The cost associated for an overhead line at this time is around \$50,000/mile and the buried line around \$100,000/mile with a 20 year replacement cycle. The current proposal is for a 0.83 mile long above ground 12.47 kV line with 40 ft tall poles (Figure 1). The route would follow Black Mountain Road and consist of the following segments (Figure 2):

- Segment 1: 150 ft across open space at the base of the dam
- Segment 2: 500 ft through sparse trees to Black Mountain Road
- Segment 3: 1900 ft along Black Mountain Road to the unnamed tributary, crossing the road as necessary to minimize tree clearance
- Segment 4: 1300 feet on the west side of Black Mountain Road to the Idaho Power Corridor
- Segment 5: 550 ft along the Idaho Power corridor to a new substation and interconnect

The impacts for a buried power line in the road right of way were analyzed in the “Combined Vegetation and Threatened, Endangered and Sensitive Species Assessment” study report. An additional 50 feet on either side of the road was also included in this study. The change to an overhead line would create the potential for avian collisions and electrocution, particularly in the 150 ft open corridor near the base of the dam. We would mitigate this potential impact by constructing the entire line to current avian protection standards as defined in the Avian Power Line Interaction Committee’s “Suggested Practices for Avian Protection on Power Lines: The State of the Art in 2006”. The overhead line would create less noise disturbance during construction compared to the buried line by greatly reducing the amount of excavation equipment required for installation. The overhead line would also avoid soil and vegetation disturbances associated with line burial, including disturbance of the riparian wetland located on the east side of Black Mountain Road at the southern end of Segment 4. The overhead line would require some tree clearance (see table below) and would introduce a small visual impact. Segment 1 would be

visible next to the powerhouse at the base of Mason Dam. Due to vegetative screening, the remaining line segments would only be visible to users of Black Mountain Road. Required tree clearance is described in the table below.

Segment	Required Tree Clearance*
1	None
2	40-ft x 500-ft corridor through sparse trees
3	A few trees
4	A few trees on the northern end of segment and a 20-ft x 900-ft corridor on southern end of segment
5	None

* Based on standard engineering practice; Forest Service may have additional specifications

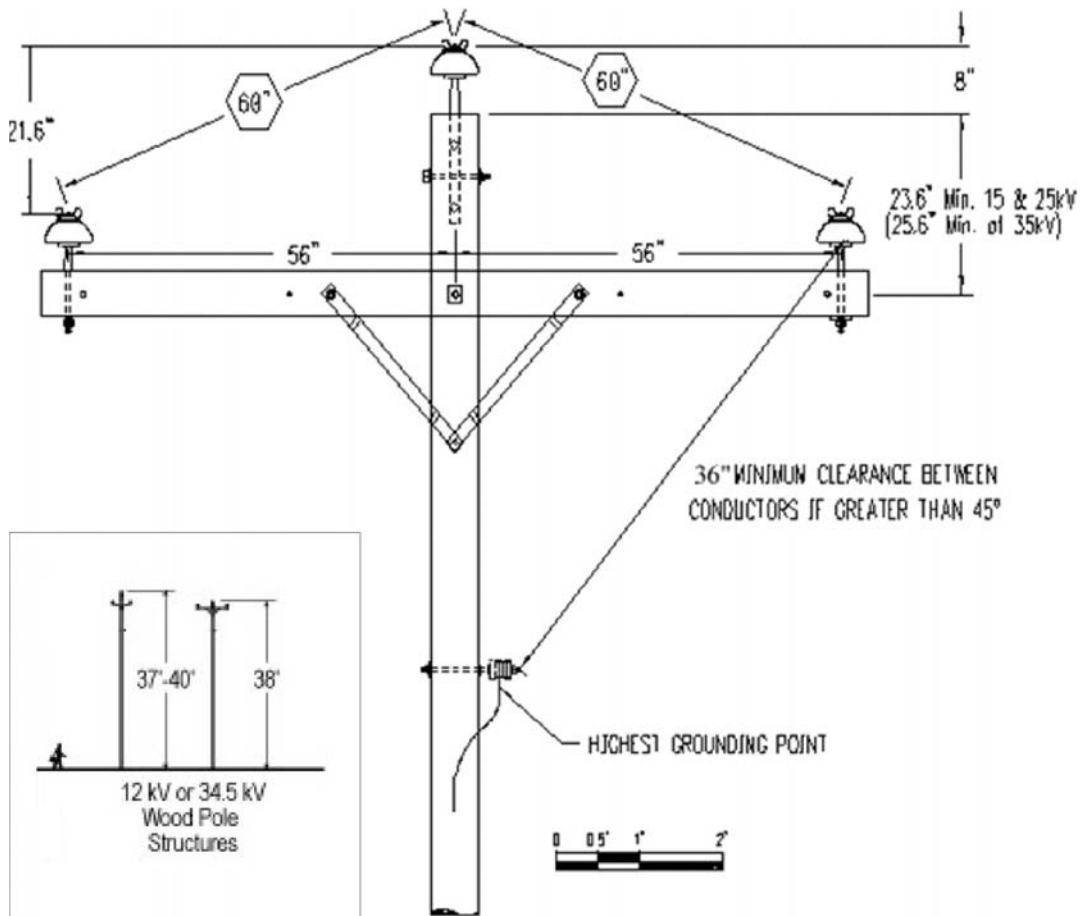

Figure 1. Typical raptor-safe power poles.

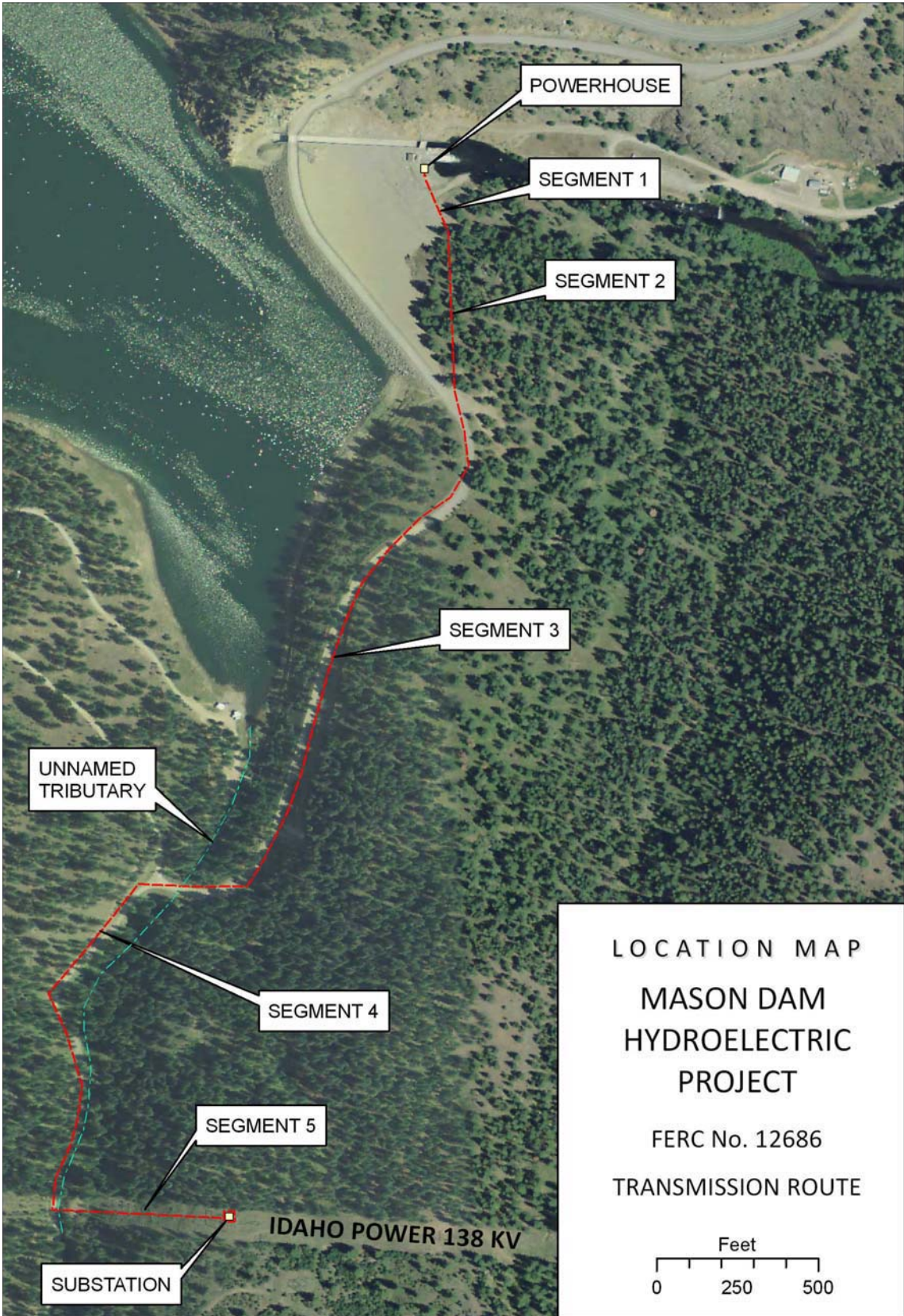

Figure 2. Proposed transmission route.

Dissolved Oxygen

Per discussion at the 20-May-2010 meeting with the agencies, it is our understanding that the applicable water quality standards for dissolved oxygen (DO) are:

- January 1 to May 15, salmonid spawning standard, 11.0 mg/L or 95% saturation.
- May 16 to December, cool water standard, 6.5 mg/L

The powerplant will be designed to generate power at flows of 100 cfs or greater. Water releases from Mason Dam over the last 10 years show that flows in excess of 100 cfs can occur prior to 15-May when the salmonid spawning DO standard of 95% saturation is in effect (Figure 3). The salmonid spawning standard is expected to be the more problematic standard owing to the difficulty of raising DO in water that is getting close to saturation.

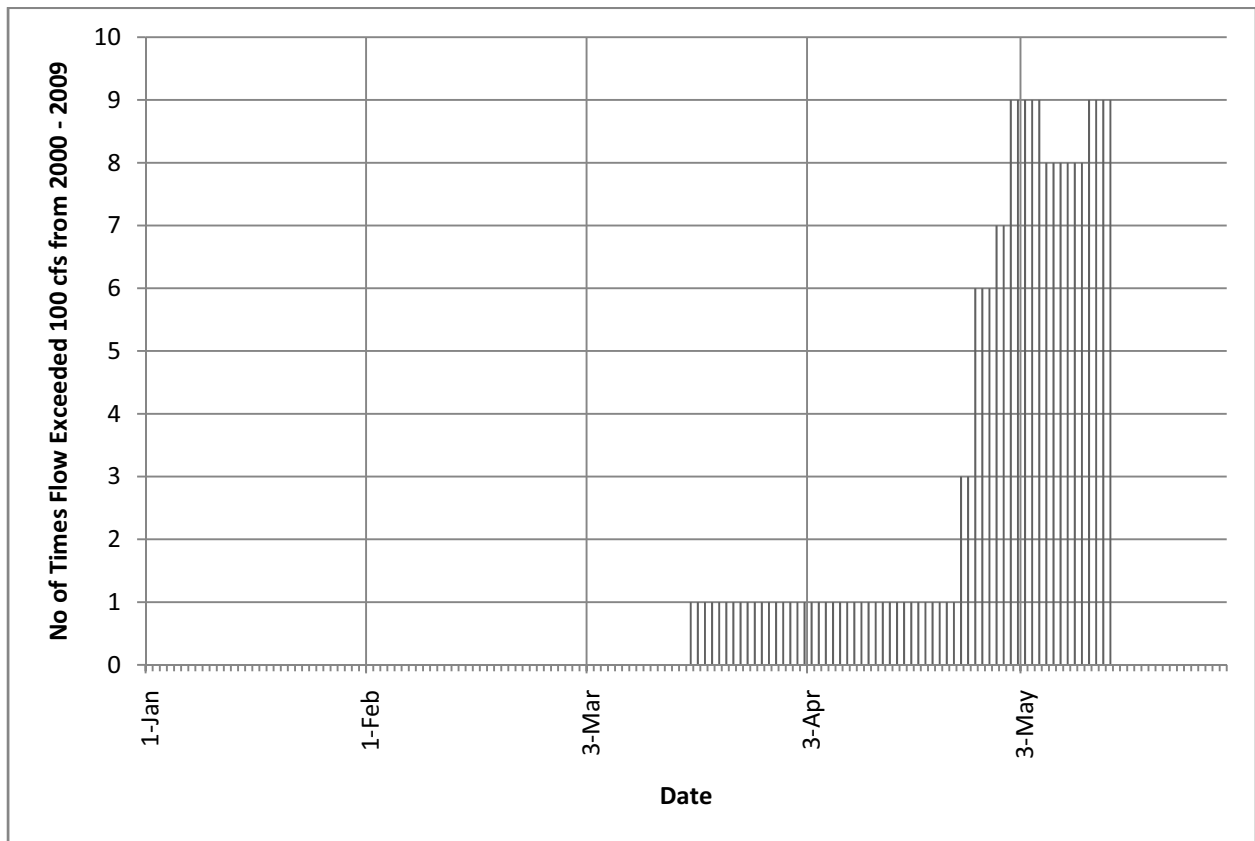

Figure 3. Frequency of flows in excess of 100 cfs.

In 2007 and 2010, early season DO data were collected upstream of the existing jet valve on Mason Dam (see Table below). These data indicate that early May releases are very close to the required 95% saturation standard for salmonid spawning.

Date	DO Saturation %
5/11/2007	89.0
5/6/2010	98.0
5/6/2010	96.3
5/6/2010	93.9
5/6/2010	94.6
5/12/2010	103.4
5/12/2010	97.4
5/12/2010	97.4
5/14/2010	90.1
5/14/2010	90.6
5/14/2010	92.2

In order to take the greatest possible advantage of the power generation potential of Mason Dam, Baker County proposes a plan to meet the DO standards year round including the early season period. The DO plan has the following elements:

1. From 16-May to 31-Dec, DO compliance will be monitored at the exit of the stilling basin (Compliance Point 1)
2. From 1-Jan to 15-May, DO compliance will be monitored at a downstream point where suitable salmonid spawning habitat begins (Compliance Point 2)
3. An aeration system will be installed on the turbine draft tube during construction
4. If at any time the relevant DO standard is not being met (7-day running average), draft tube aeration will be initiated to increase DO
5. From 16-May to 31-Dec, if the DO standard cannot be met at Compliance Point 1 using draft tube aeration, some of the flow through the turbines will be re-routed through the existing jet valves until the cool water standard is met
6. From 1-Jan to 15-May, if the DO standard cannot be met at Compliance Point 2 using draft tube aeration, one or more natural rock aeration weirs will be constructed in the river channel above the compliance point; as an interim action until the weirs are completed turbine flow will be re-routed through the existing jet valves until the salmonid spawning standard is met.
7. After construction of aeration weirs, re-routing of flow through the existing jet valves will remain as a final option to meet the salmonid spawning standard.

The location of Compliance Point 2 will be based on river bed conditions, in particular on substrate conditions suitable for salmonid spawning. Observation during previous studies indicated that the river bed has been scoured for some distance below Mason Dam and could not support spawning. We would propose a site visit by project and agency fishery experts to evaluate and select Compliance Point 2.

From Baker County's standpoint, one important element of the DO plan is that Compliance Point 2 is located far enough downstream to provide sufficient elevation drop for construction of effective weirs. A second important element is that the design, construction and use of aeration weirs is pre-approved under the FERC license, with agency concurrence, so that the weir(s) could be built with a minimum of lost power generation. The final license application will include weir design drawings showing detail sufficient to assess performance and resource impacts. The optional installation of weirs will be an integral part of the licensing proposal.

Fish Entrainment and Turbine Mortality

Baker County does not propose to construct a fish screen on the Mason Dam intake structure as originally intended. This change became necessary after a thorough evaluation of the engineering, economic, water management and fishery issues that accompany screening of a deep intake such as the one at Mason Dam. The major points are:

- The submerged screen structure would be very large to meet screening standards and accommodate the required 875 cfs flow (the design capacity of the outlet works), and would require construction of a tower over 100 ft tall in order to access the screen for repair, maintenance, or emergencies. We could find no examples of screens that have been successfully installed at sites having similar water depth and flow conditions. The cost of a viable structure is estimated to be in the range of \$1M to \$1.5M, which renders the hydroelectric project non-economic (Attachment A).
- The screen must be capable of reliably passing water for irrigation, flood control and fishery habitat purposes; any failure of the screen resulting in impeded flow could have significant consequences for downstream agriculture, human property and safety, and Powder River fish and wildlife communities, and dam safety. We fear that the agricultural community, and downstream floodplain inhabitants would strongly oppose any screening plan. Reclamation has mixed feelings on the idea, they understand where the agencies are coming from but are worried about its implementation.
- The hydroelectric project will not change the existing rate of fish entrainment. We presented analysis in the PLP that suggests that fish mortality through the hydroelectric turbine would likely be lower than what currently occurs through the existing outlet valves. On the basis of this analysis we respectfully suggest that in lieu of the fish screen, an entrainment/mortality study be completed based on existing information.

As part of our final license application, we will include an updated review of the turbine mortality analysis through continued consultation with the stakeholders. This analysis is being done to satisfy the entrainment/mortality requirement that was waived by the agencies when the fish screen alternative was originally proposed.

Baker County is eager to move forward toward developing this valuable renewable energy resource. We wanted to provide an outline of our proposal to continue the development and progress of this project. We are willing to explore opportunities for joining with the agencies to develop other measures that would benefit the resources of upper Powder River basin including continued perch removal operation and discussions of agency items already identified.

Attachment A

Evaluation of Submerged Fish Screen Feasibility

To evaluate design options, we investigated existing submerged screen installations throughout the western US. Detailed information was found for five submerged fish screen projects, all in Pacific Northwest watersheds where ESA-listed salmon and steelhead are found. Tables 1 and 2 below summarize the key engineering parameters for the five screens in comparison with Mason Dam.

The closest project to Mason Dam in terms of water depth is Howard Prairie, with a water depth of 57 feet compared to 95 ft for Mason Dam. The Howard Prairie screen structure is much smaller than would be required at Mason Dam due to the maximum flow of 95 cfs compared to 875 cfs for Mason Dam. Additionally, the Howard Prairie installation capitalized on an advantageous intake configuration, which permitted deployment of the screen using rails on the embankment of the dam itself, i.e. no new tower structure was required. This design would not work at Mason Dam because the current intake is not located on the dam embankment; the Mason Dam intake is elevated above the reservoir bottom near the upstream toe of the dam.

The other four designs were located in shallow water. Except for East Unit, which is a pumping station rather than a dam outlet, the screen designs included new tower structures to provide access to the screens. A corollary tower structure at Mason Dam would be a much more significant structure due to the screen size (875 cfs) and water depth (95 ft).

An initial estimate of the cost for a tower and screen at Mason Dam is provided below:

ITEM	DESCRIPTION	ESTIMATED COST	NOTE
1	Tower foundation	\$400K - \$600K	Submerged
2	Tower	\$400K - \$500K	Submerged
3	Access catwalk	\$100K	From dam to tower
4	Screen	\$200K	~1,750 sq ft total
5	Screen cleaning system	\$300K	Rake system
6	Standby generator	\$40K	Deploy screen during power outage
7	Reclamation review and inspection	\$150K	
TOTAL		\$1,590K - \$1,890K	

At \$1.6M – \$1.9M, the screen would increase the project cost by 40 – 48%. This would equate to an additional \$25/MWH cost to produce power, which would have to be recovered through a higher power purchase price. We do not think that a buyer could be found at this price.

For comparison purposes BOR provided cost information on the screen at East Unit and Brewster. In a Predesign Memorandum done in March 1997 for East Unit, estimated total construction cost for the work was \$580,000. The annual OMR&P was estimated to be around \$5,000. As mentioned in the stakeholders work session it is not the cost of the screen but the extra improvements that will be needed. For the East Unit the cost of the screens were estimated at \$77,500. Changes from this design to Mason Dam as discussed over the phone with BOR would include the following. Building a selective intake tower because there is no “sweep” for the air bust system and the intakes need to be well above the silt lines. To do this you would have to have a separate structure. This separate structure would connect to the main cement pipe between the current intake and the middle bulk head gate by core drilling into it. Then a couple of bulk head gates would be installed so that water could either flow just through the screens or the existing intake. For Brewster they could not dewater the area, similar to Mason Dam and they had to use divers and cranes to set the footings.

Table 1. Specification for Submerged Fish Screens at Other Sites

PROJECT	STREAM	BASIN	OWNER	OUTLET WORKS	MAX FLOW (CFS)	NORMAL HIGH WATER ELEVATION	DEPTH TO TOP OF INTAKE STRUCTURE	DEPTH TO INTAKE SILL
Mason Dam	Powder River	Powder River	Reclamation	Submerged tower	875	4071	83	95
Fish Lake	North Fork of Little Butte Creek	Rogue River	Reclamation	Tower to surface	300	4642	Above high water	23
Fourmile	Fourmile Creek	Rogue River	Reclamation	Tower to surface	85	6003	Above high water	24
Howard Prairie	Beaver Creek	Rogue River	Reclamation	Gate on Embankment	95	4527	54	57
Hyatt	Keene Creek	Rogue River	Reclamation	Tower to surface	440	5016	Above high water	35
East Unit	Columbia River	Columbia River	CID	Pump	75	613	Above high water	14

Table 2. Drawings/photos of Submerged Fish Screens at Other Sites

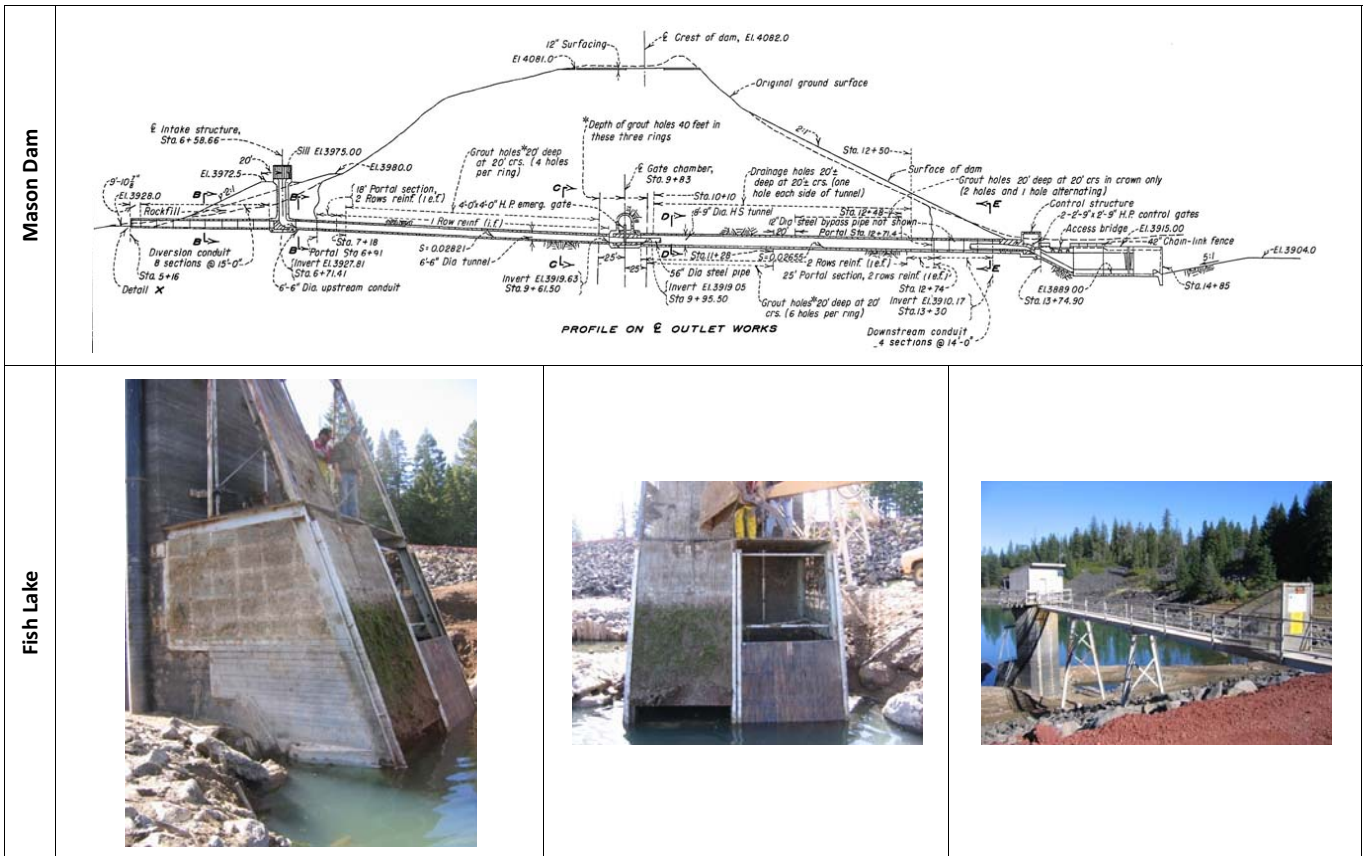

<p>Fourmile</p>		
<p>Howard Prairie</p>		



Mason Dam
Michael Gerdes to: jyencopal

08/17/2010 09:41 AM

From: Michael Gerdes <mgerdes@fs.fed.us>
To: jyencopal@bakercounty.org

Good Morning Jason. Received your phone call re: the T-line. I would request that you send me your proposed T-line route so we can review it. Want to check the route against the BEMA area, any potential disturbance to eagles, riparian areas, etc. Looking forward to working through these issues, including the entrainment issue as to help move the project forward. Many Thanks. mg

Mike Gerdes
USDA Forest Service - PNW
541.416.6521
mgerdes@fs.fed.us



Mason Dam - ODEQ Contact

DEVITO Paul to: jyencopal

Cc: "KIRK Steve"

08/16/2010 02:11 PM

From: "DEVITO Paul" <DEVITO.Paul@deq.state.or.us>
To: <jyencopal@bakercounty.org>
Cc: "KIRK Steve" <KIRK.Steve@deq.state.or.us>

Hello Jason,

Just wanted to drop you a quick note to let you know of the new ODEQ 401 contact for Mason Dam. Steve Kirk, copied here, has been with ODEQ's Bend Office water quality program since 1998. I've briefed Steve on the project. Please feel free to contact Steve directly with questions or concerns relative to the 401 process for Baker County's proposed Mason Dam hydro project.

Steve's contact information:

Kirk.steve@deq.state.or.us

Ph. (541)633-2023

Thanks, Paul



Minutes Edits

Colleen Fagan to: jyencopal

07/12/2010 10:24 AM

From: "Colleen Fagan" <colleen.e.fagan@state.or.us>
To: <jyencopal@bakercounty.org>

Hi Jason:

Just a few edits for the meeting minutes. I focused on ODFW issues of concern.

Colleen

Colleen Fagan
NE Region Hydropower Coordinator
Oregon Department of Fish and Wildlife
107 20th Street
La Grande, OR 97850
(541) 962-1835



May 20 2010 Work Session Minutes no exhibits cef edits.docx

Mason Dam Work Session
May 20, 2010

Minutes

In attendance

Colleen Fagan – Oregon Department of Fish and Wildlife
Mike Gerdes – USDA Forest Service
Mike Hall – USDA Forest Service
Leslie Gecy – Eco West Consulting
Nick Josten – Sorenson Engineering
Ted Sorenson – Sorenson Engineering
Randy Joseph – Baker County
Jason Yencopal – Baker County

On the phone

Ken Hogan – Federal Energy Regulatory Commission
Joe Hassel – Federal Energy Regulatory Commission
Alan Richey – Oregon Department of Fish and Wildlife
Mary Grainey – Oregon Water Resources Department

Discussion Items

Transmission Line

Baker County, as discussed last meeting, was looking at other options of interconnection with Oregon Trail Electric Co-Op (OTEC) versus Idaho Power. Through continued discussions it does not look like the OTEC option will work. Ted added that the reason OTEC is not feasible is that the interconnection line does not have the “take away” capacity. Baker County will present its preferred method in the license application.

Mike G. asked if the original route that goes up Black Mountain Road is still going to be buried. Jason stated that the original proposed route is still being considered but Baker County is also looking at an overhead line due to the economics and habitat disturbance. Ted added that originally they were looking at a straight overhead route that required clearing trees because underground is expensive especially if the ground is rocky. Ted would like to work with the agencies to look at the option of zigzagging an overhead line up the Black Mountain road. Mike H. stated that the Forest Service’s preferred option would be underground. Mike H. understands that if technically the power can not go underground that is one issue. To which Ted replied that it is a lot of energy to put underground and Mike H. agreed that then this would be an issue that would need to be considered.

Mike G. wanted to clarify what Baker County would put in the license application. Would there be two proposals or would one be chosen and put in the license application? Ted said that one would be chosen and submitted in the license application.

Mike G. added, looking through the December meeting notes, that if the overhead is following the underground then the Forest Service will need to look at the Forest's Plan and the right of way restrictions because all the studies were based on an underground line versus an overhead line. Mike H. added that in the analysis the Bald Eagle Management Area (BEMA) would need to be considered if the line is overhead.

Nick thought that the information collected from the studies would be adequate enough to evaluate either option but Baker County has not evaluated the overhead option. Mike H. stated the only thing not addressed with the underground option was the BEMA.

There was some discussion on the eagle nest and the distance from the road and the BEMA boundary. Leslie clarified that the edge of the BEMA is the West edge of Black Mountain Road.

Mike G. said technically if the overhead line stays outside of the BEMA it would meet the bald eagle needs and it would also meet a lot of our concerns of the underground line going through riparian areas. The question that the FS would need to answer is what the current right of way is and what additional clearing would have to occur for an overhead transmission line.

Mike G. agreed with Nick that information from the studies should be able to evaluate the overhead line and added that from a cultural standpoint that if Baker County has cultural clearance then drilling new holes for the poles could be an option. Mike H. added that if Baker County is going to be following the same line then there will be less disturbance than digging a line up the whole road.

A question arose about who would be issuing the authorization for the power line, FERC or F.S. Since it is in the project boundary, FERC would be authorizing the transmission line and no special use permit would be issued by the F.S. Ken's understanding was that the F.S. would still issue special use permits for FERC licensed hydropower projects. Mike G. stated that he would check on the dates of issuance versus non issuance but his understanding is that even on new projects because we are past 1976 we don't need to issue any new SUA (Special Use Application) if it is in the FERC Project Boundary.

In an e-mail from Mike Gerdes to Ken and myself dated June 1, 2010, Mike found the following:

*The Energy Policy Act of October 24, 1992 amended the Federal Land Policy and Management Act of October 21, 1976 and specified that a SUA is not required for any existing project, whether licensed or granted and exemption that was not subject to a permit under the FLPMA prior to October 24, 1992. However, a SUA is required for all **NEW** hydro project proposed after October 24, 1992. As Mason Dam is a new project it will be required to obtain a SUA from the FS.*

Ken wanted to clarify that the proposed interconnection at the base of the dam is no longer an alternative. In which Ted replied "That is correct."

Baker County will provide a typical pole detail that will comply with the avian manual as well as the clearance needed based on what we would like and what is needed.

Leslie asked what the height and spacing of the poles would be. Ted thought it would look similar to the distribution lines currently in the area, the spacing will depend on the zigzag of the road. If it was a straight line the poles could be spaced 500 feet apart. An estimated spacing would be 300 – 500 feet. Randy added the height would be around 35 to 40 feet.

Dissolved Oxygen

Current Water Quality Standards are:

From January 1 to May 15 are the salmonid spawning requirements of 11.0 mg/L or 95% saturation.

From May 16 to December 31 is 6.5 mg/L.

In the December meeting Paul DeVito originally ruled out the original phased DO plan of draft tube aeration, bypass release, and rock weirs. Since this time Paul called and discussed potentially moving the compliance point down-stream to site 4 as defined in the Water Quality Study which is just downstream of the stilling basin (.05 miles exhibit 7). Baker County discussed having two compliance points one being for the 6.5 mg/L standard and the other for the 11.0 mg/L or 95% saturation standard (.16 miles exhibit 8). Leslie will discuss the information that Baker County used to consider two compliance points. Leslie described that during the T&E TES species survey, aquatic invertebrates were looked for in the reach from the dam down to the gauging station. The study was done in October due to low releases so that the substrate-straight could be examined. The substrate-straight consists of mostly boulders and very few fines in that stretch. The study was not for spawning but while looking for mussels it was determined that there was no habitat because there was nothing for them to burrow into and aquatic invertebrate habitat would be limited for the same reason, lack of substrate-straight.

Colleen informed us that when Paul called and discussed the compliance point with her and Tim Bailey, the district fish biologist, that Paul also asked about the extent of red-band trout spawning habitat. For ODFW it is right up to the stilling basin based on the observations of the planted salmon attempting to spawn in that area.

Leslie asked when the spawning activity had been observed. Colleen stated that she had not personally observed this but Tim Bailey, the district fish biologist, had from monitoring the salmon activity. Leslie wanted to clarify the location as the habitat really changes below the gauging station. Colleen said that she will have to talk with Tim more but in their conversations Tim's expectation would be that spawning would occur the compliance point be up to at the end of the stilling basin. Randy wanted clarification that these observations were from the salmon that had been released by ODFW for anglers to fish for, to which Colleen affirmed. Nick asked Leslie if there was habitat information on the stream channel and would we be able to look at the spawning requirements for red-band and compare that to the existing mapped habitat to make a determination as to whether there appears to be suitable habitat. Leslie would like to talk to Tim and see exactly where he saw them spawning and discuss his observations.

Ken asked "If it is documented that there is spawning up to the stilling basin does that effect your proposal?" The answer to that question is yes, according to Ted. The reason is that in May the water has around 9 – 10 parts per million naturally. In order to reach 11.0 it is approaching

saturation or super saturation depending upon the location (elevation and temperature). To do this by mechanical means becomes very difficult, theoretically it is impossible to do this so Ted always looks for natural means of aeration with boulders and distance. It is getting from 9.5 to 11 that is very difficult. The .16 miles is very valuable so that you can use natural means to reach saturation.

Ken asked how often the project would operate during the stricter criteria. Ted discussed that the irrigation season that will vary from year to year but in Jan – March on most years there will be the minimal discharge of 10 cfs but irrigation season may start in April or May depending on the run off. Jason gave the example for this year releases on May sixth they were releasing 19 cfs, May twelfth 63 cfs, May thirteenth 202 cfs. The project is designed to generate as low as 100 cfs and would have only been able to operate May 13, 14, and 15. There are years depending on the snow pack and rain fall that increase flow could occur in April and May to ensure the reservoir does not overflow.

ODEQ

Jason wanted to update the stakeholders with the information that Paul DeVito had accepted a different position and would no longer be working on the Mason Dam project. Baker County has not heard who would be taking on Paul's duties at this time.

In an e-mail received from Paul DeVito on 6/24/2010 it has yet to be determined who will cover some of the hydro projects he was working on.

Phased DO Plan

Before Paul left for his new position he had discussed on the phone with Jason the possibility of adding rock weirs as an option ~~if since~~ the compliance point ~~is had been~~ moved downstream. Before moving on Nick wanted to clarify with Colleen that the need to establish a basis for determining where spawning occurs and the principle behind moving the compliance point down stream to where spawning occurs is because of the standard that applies to spawning and if that makes since. Colleen stated that she understood that but we would need to talk to Tim to have a better understanding of where the spawning is occurring, and if there is spawning in that reach ~~the standard #~~ would ~~not~~ apply immediately below the stilling basin.

(Colleen discussed redband trout spawning with Tim Bailey and determined that if there are any pockets of gravel in the reach immediately below the stilling basin redband trout will use them for spawning. Therefore, ODFW considers redband trout spawning to occur up to the stilling basin.)

Formatted: Font: Italic

Draft Tube Aeration

Up until May 15 the higher DO standard would be in affect, and then after May 15 the standard is 6.5 mg/L. Usually most reservoirs you have 6.5 and Ted questioned Mason Dam being low until reviewing the data.

Ted discussed the design of the turbine layout. The turbine has been changed from a vertical shaft to a horizontal shaft and this changed the water being discharged from the turbine into the draft tube above the tail-water level. This creates a ventur~~ie~~ie effect that once you open a valve air naturally enters the pipe turning the draft tube into an aerator. Generally the DO can be raised from 2 parts per million to 6 or 7 parts per million, with draft tube aeration very naturally. If the standard is not met then the turbine would be shut down and the water would exit through the existing valves. There would also be times where the discharge would be a mixture from turbine and existing valves. The plan to meet the 6.5 mg/L would be to use the draft tube aeration along with bypass flows when needed to meet standards.

(In the meeting, Ted mentioned shutting off the turbine completely and going just with the existing valves if the standards are not being met. To clarify, we would first start bypassing flows through the existing valves while still operating the turbine. The amount of bypass would change depending upon the results. If the bypass flows require so much cfs that the cfs diverted to the turbine is lower than 100 cfs then the turbine will be shut down.)

Ted explained that mechanical aeration would consist of motors and pumps much like sewer lagoons that are not as reliable and are expensive. The issue with approaching saturation for the January 1st through May 15th standard is that if .16 miles is allowed natural aeration of the existing channel and of use rock weirs can augment the DO to meet the standard. Rock weirs can also add fish habitat and look very nice once completed. To meet the high standard of 11.0 mg/L or 95% saturation we want to use the draft tube aeration, bypass flows, natural aeration of the stream augmented with rock weirs if needed, would be used.

Colleen asked what other options are available if the compliance point is not moved down .16 miles.

Ted said the next option would be to install a labyrinth weir, made of concrete and steel, in the stilling basin (see exhibit 9). This type of weir is more expensive than a rock weir.

Mary would like to see a photo of the rock weir and some estimates of increased habitat that could be created.

Ted has built a rock weir on the Tiber project in a “V” because of the concern of bank erosion. The weir does not necessarily have to be a “V” but could be an arch or straight line (see exhibit 10).

Ken added that his recollection of this section of Powder River has a series of rock weirs across it for habitat.

Leslie thought there has been some rock weirs placed in the stream done by the Forest Service.

There is not really a rock weir per say but boulders have been placed in a random fashion from the stilling basin to the gauging station. See exhibit 11 for a photo.

Randy asked if the existing river is not adequate to meet the needs.

Ted would like to do a phased approach as was negotiated at the Tieton project where it is being monitored and if the standard is not being met then the rock weirs will be added.

Randy wanted to clarify that the rock weirs would come later in the project and not up front, which was the correct understanding.

Ken asked that under a phased approach, is it the proposal that at any point in time in the monitoring that the project does not meet the standard you would shut down and go through the valves.

Ted's reply was yes in this case up until May 15th as long we had assurance that we could put the rock weirs in forth with so we did not have to be shut down for more than one season. We would be in trouble economically and that seems reasonable to him.

See previous comments on shutting off the turbine

Colleen stated that the project will need to meet standards and if it does not, it can not continue to operate.

Ted described that on a project in Washington that if they did not meet the equivalent of 11.0 but are between 9.5 and 11.0 they were given a grace period of one year to then install the rock weirs. If they were below 9.5 then the project would need to be shut down. Ted thought that in this case of Mason Dam that it would be reasonable to give a range that the project needs to operate in and then install the rock weirs the next year if it is not meeting the standard.

Mike G. stated that from a Forest Service/NEPA stand point we would like to see the rock weirs analyzed as the preferred alternative. This way if the rock weirs are needed the Forest Service could say go ahead and install them. If the rock weirs are not included in the original plan then a separate NEPA analysis would have to be done to evaluate the addition of the rock weirs.

Colleen added that a lot of this is going to depend on what Oregon DEQ allows and we need to keep in mind that the red-band trout is a [state](#) sensitive species.

Nick clarified that from a project standpoint that if the project had an emergency to shut down due to a DO issue, some assurance would be needed that the project could then fix the problem and start back up. Ted added that we will need a plan B set ahead of time. Mike G. added that as part of the monitoring plan that plan B, the installation of rock weir, and have that analyzed up front, this way there would not be a separate analysis for installation.

Joe in considering the releases made this year and that how little impact that would of happened this year because the releases did not come up to where generation could occur but only a couple of days before May 15th asked, is there any way to estimate how much energy would be lost if the project could not generate before May 15th? Ted stated that in hydro the past is the future and that by looking at the past hydrology of 20 years that it could be analyzed. Joe agreed with Ted's statement about the past being the future in hydro.

Nick stated in the PLP, the existing data was compiled and the flows averaged 100 cfs in April and could not be written off. Ted added that April could be written off in any given year but year in and year out it could not and that is why we are looking at these rock weirs.

Ken asked that if it is determined that spawning does occur up to the dam, there would not be much head for the rock weirs to work, what does this do to the tiered plan.

Ted replied that it would make things difficult. Randy added that in that case plan b would be to use a labyrinth weir, to which Ted agreed.

Ken asked if there was a way to model the DO from the draft tube based on the monitoring that had been completed.

Ted for an example said lets look at early May this year and asked Jason what had been recorded with the reply being 9.91 mg/L. In Ted's book 9.91 is saturation or pretty close, 11.0 or higher is possible but not through mechanical means. The driving force needed to drive oxygen into solution is divided by the difference between saturation and the current reading, equaling a very small driving force. The only way to do this is naturally where you have distance and time to do it. Randy wanted to clarify that the standard is 11.0 mg/L **OR** 95% saturation, correct? At this location and elevation isn't the DO percent a function of elevation and temperature, so what would 95% saturation be at 3900 ft and 50 degree water temperature. Jason added that one reading he took was that the mg/L was 10.05 and the percent saturation was 95.1%. Randy stated that maybe we are a lot closer than we think we are, because 11.0 is probably to great of a number for this elevation and water temperature. Ted suspects that we are going to be very close but it is that very close to being there and it is that last little bit to get there by mechanical means that is very very difficult. Ken asked that based on what was discussed earlier that the draft tube aeration would raise the DO 2-4 points, would that not be enough? Ted replied that as saturation is reached the draft tube aeration is not as effective. Ken understood this but thought it could improve the situation from 9 to 10. Ted added that the draft tube aerator could not be counted upon to improve the DO from 9 to 10 but instead 9 to 9.4. As it gets close to saturation that last 5% gets to be very difficult. From Ted's research he has not found any documentation where draft tube aeration working near saturation, where they shine is in the 4 to 6 or 0 to 4 mg/L range.

Fish Screen

Baker County's original understanding was that the study proposed, the entrainment study, and the fish screen were going to roughly be the same cost, \$250,000. So Baker County looked at the study and regardless of the findings it looked like the outcome could potentially be to screen. So the County looked at spending \$250,000 once versus twice and this is where the proposal of screening the intake originated. Randy added that when we first started the project he had done most of the analysis, and the entrainment study was very difficult to do. The suggestion from ODF&W was to use rotary screw traps. These would not work in our river system since it was too small. Also the fact that what ever the entrainment was determined, it still did not address could a bull trout come down stream and go through the project and be hurt in some fashion and would that be a problem. There was not an absolute given. Even if the findings were there was

not a problem with entrainment, that we could get the result that we were after and that was the most confusing part that even if the study was done we would still not have any definite conclusion that we could not screen. Ted has brought a lot more information forward since the time of the original proposal.

Colleen wanted to clarify the history as ODFW understands it. In lieu of conducting an entrainment study Baker County proposed to screen. If screening did not occur then an entrainment study would occur as found in the study plan.

Mike G. also stated that his understanding was also that screening was in lieu of the entrainment study and if there was no screen then the County would go fourth and do the study.

Nick agreed with these statements and added that what we have done is changed the proposal. What we propose now is a hydroelectric project without a screen. The impact analysis done over the last year and a half or so has not taken this into account. So now we need to address the impact of building a project without a screen. Baker County proposes to look at this. It involves entrainment and mortality of fish. The entrainment is not going to change since the water is going to be withdrawn in the same amount as it always has been through the same intake, the same number of fish will be entrained as there has been historically. So there would be no change, screen or no screen, actually there would be a change if there was a screen there would be no entrainment. Colleen agreed that there would be no entrainment if there was a screen.

Nick clarified that there would be no increased entrainment compared to existing conditions. So what it comes down to is mortality. How do we want to address this, discuss why the screening is probably a project killer, or address the fact that we have changed the proposal? Ted wanted to address why the screen is a project killer. It is not impossible to put a screen on this deep intake from an engineering standpoint but it is economically impossible. It would cost more than the plant to do. In Ted's research and experience, building three projects on BOR dams two of which are similar to Mason Dam, searching all the way up into the Montana region or Boise region, he has not found any projects with submerged screens. Jason had found some screened projects in Oregon; these are primarily irrigation system and around 75 cfs versus 800 cfs. We would have to build a tower around this intake to mount the screens to and be able to pull them out for cleaning. He also called Steve Cramer and Associates out of Gresham and asked if they had run across any of these deep intake screens. They were not aware of doing this, there may be one or two out there but it is not a common thing. ~~It is~~ Regardless of the common thing it is an economic deal killer, if there is to be fish screen on this project. Alan stated that he had not heard a cost estimate for the screens. Hendrick screen had contacted him yesterday or the day before and was not sure if they have supplied an estimate. Jason has been working with Hendrick's to get a cost estimate and recently called to check on the estimate in which they must have called Alan to get the specifics for the screen. Alan talked to him this week and reminded him that no fry are present which would cut the cost of the screen in half. Ted stated that he was not basing the cost of the screen on the screen as the cost would be nominal, but the cost is based on the cost of the tower and the fact that you can not fully dewater the reservoir to construct the tower. Randy added that when he originally bid the screen from Hendrick's it was probably based on to low of a cfs number and did not take into consideration the emergency aspects and dewatering the reservoir, that is why there is such a price difference in what was originally proposed. Alan asked for clarification about the 800 cfs. Jason responded that the max release

of Mason Dam is 875 cfs through the outlet works, not over the spillway. The spillway has never been used at Mason Dam. The project is designed for a maximum of around 300 cfs. Alan asked what was the flow design given to Hendricks. Jason said that if the screens were built over the existing intake that they would have to pass the full 875 cfs, however if there was some sort of emergency bypass valve that could be opened and separate from the screens then all the project would need would be a screen based on 300 cfs.

Ken asked for an explanation for the need of the tower and why some sort of steel super structure could not be placed on top of the intake that came to the surface. Ted replied that a separate structure would be needed for a way to access the screens for maintenance and operation.

Alan discussed that in other situations they have installed similar screens as the Johnson folks and had screens that were on rails so the screens could be put in place and taken out for maintenance. Ted understood this and added that the rails would still need a tower super structure to mount to which would be up to 100 feet tall and something to set it on. Alan added that you may not have to necessarily go straight up and down but could angle it up to the shore. Jason commented on the current intake and information received from the Shawn Foster who was working on the bids from Hendrick's. He was saying that what ever our screen would be we would need a buffer of half the screen width for the airburst system to clean the screen. With the current intake if we tried to put something on it there would not be enough room from the sill to the dirt and we would also have to be out of the silt line because there is no sweep velocity so we would need a tower of some sort. Alan would like to see what the estimate would be when it is complete. Randy stated that he had one concern, that the Bureau of Reclamation has not given their input on this and they would have the final say on this. Ken asked if the Bureau of Reclamation has been consulted on the screen design for Mason Dam. In which both Ted and Jason answered we have been talking and working with them. Ted continued by saying that he has been talking to them. The Bureau wants to know what is going to be done about plugging the screens and what steps are going to be taken so they don't plug. From experience with dealing with the BOR it is not inexpensive because they have very high standards.

Ken stated that it sounds like the next step is to figure out the actual screen costs versus the alternatives. In which Alan added that this would also be his suggestion.

Mike G. asked how big is the intake structure of Mason Dam. Jason showed the group exhibit 5 and added that the dimensions are 17' wide and deep and 13' high. Additional discussion took place over the possible railroad tracks down to the intake and the depth of the intake which varies due to water level. Jason will provide numbers of the data. In 2007 when the water quality study was done, it was declared a drought year.

Ken clarified that regarding the cost for the original screen was \$250,000. How much more is it and what is the magnitude.

Alan asked if Jason was expecting a proposal from Hendricks. Yes, but that will be just for the screen. Alan added that they would not be quoting the tower structure. In which Jason added that they would not. BOR is going to provide him with information from two of their projects pumping projects that they did add screens to ten years ago. Brewster 47 cfs and East Unit 75

cfs, both of these projects have the rail system and a depth of around 25 feet. The difficult part about these projects is finding a location where there was some sweep velocity so that when the screens air burst the debris was swept away, they were not able to work in the dry bringing in divers and cranes. Nick added that in these projects the screens could be removed for the irrigators to receive their water. For Mason Dam he would imagine the process would be lengthy with BOR to ensure that the water flow is not disrupted and what kind of back up is available. Nick added that he found three BOR projects in the Bend area with the deepest being 55ft, one with rails down the dam to the intake and the other two with tower intakes.

In an e-mail received from Shawn Foster, who was working to get a quote from Hendricks, on 6/22/2010 stated:

The screens are perforated plate, sorry, we won't be quoting them.

Ken asked Nick about the screen proposal and identifying the issues to propose an approach to move forward. Nick added that Baker County is going to build a hydro project without a screen and that impact has not been evaluated. The two elements of the impact are the entrainment and mortality of the fish going through the outlet works. The entrainment will not change from existing conditions. For mortality, the work that needs to be done is evaluating the mortality of fish going through the existing gate valve versus a francis turbine. Work has begun in looking at a paper study for turbine mortality that was presented in the PLP and that is what would be used to estimate the turbine mortality and we would update that with new studies that have been done in the last ten years of similar projects. The estimate of mortality through the existing system has not been done at all and the proposal would be to also conduct a paper study based on mortality studies done at other locations with similar valves. Nick has started conducting this study and there are some studies available, not a lot of them but some. From his understanding of these studies the type of valve makes a big difference. If it is a type of valve that places a blockage over the flow in the conduit it creates a surface for fish to strike against, creates a low pressure zone where cavitations occurs, and these tend to be very hard on fish, which is similar to Mason Dam's valve that lowers a gate into the flow. The other type of valve is something like a clamshell valve that shapes the orifice and make it larger or smaller but keeps it uniform and these valves tend to keep the water in stream line flow they don't have anything in the middle for the fish to strike against and have lower mortality. The proposal would be to continue to locate all the information we can find on these types of valves and make a comparison to the valves at Mason Dam and base our estimate of mortality from these studies. Because these are estimates and there may be some uncertainty in the results more may need to be done, however, from a study that was conducted at Tieton Dam in Washington the results were so far apart that a general assessment could be made. So the proposal would be a phased approach that a paper study be done and then determine if more is needed.

Ted said he thinks it would be similar to Tieton in which there was a 90% plus mortality rate. Mike G. also added that while we are gathering data to look at Bowman Dam near Prineville Oregon. There is a lot of escapement with a lot of survivability of trout coming through; however they have a lot of gas bubble disease. Nick then talked about the study for Wickiup Dam because it was found that the survival rate through the turbine was greater than the valves and the fish being passed could be a detriment to the river below. It has been documented that in some cases turbines are easier on fish than valves. Mike G. asked if francis turbines are the

turbines proposed at Wickiup Dam. It was not sure of the type of turbine at Wickiup, possibly a Kaplan but a Francis is being proposed at Mason Dam.

So the proposal for impact analysis of no screen is to look at similar projects with valves, similar projects with turbines and make an assessment based on the findings.

Alan asked if our expected outcome of mortality would be lower with the proposal at Mason Dam, in which Nick replied yes. Alan continued that you will still have x percent mortality, how will you know how many fish will be entrained at this site. Some things can relate from project to project when the equipment is similar but the actual lake and the fish populations will not be similar, how will actual entrainment numbers be captured. Nick replied that we will not, we will say that the current entrainment is X and it will still be X after the project is installed and so it is nothing that we have any affect on.

“So what you are saying is that if the mortality goes down, then the project is not having any affect?” asked Colleen.

Nick responded that there would be more fish surviving down into the river than is currently the case, how many more, we could not say but there are more than before.

Colleen added that we would not know how many fish are being killed, what the population impacts are, or how it relates to fish species and size of fish, or other factors which would be a concern if we don't get down to those specifics to help determine what the impacts would be on the native population. On this project what we are looking at would be non native fish passage into the Powder River and we are talking about yellow perch.

Nick responded that all we could say is that there would be more fish surviving.

If the case is being made for the project not to screen, Alan's expectation is that there would be some sort of mitigation being proposed at some point based on the number of fish being killed at this site.

When Nick does these analyses, he bases them on existing conditions as the base line that we are measuring impacts relative to. In this case, if more fish are surviving once the project is completed than before, then there would be no negative impact unless it is a case such as Wickiup where they don't want the fish to survive.

Alan will have to look into that scenario; it looks like there is still an unknown number of fish being killed as a result of the project that we will not have a handle on.

Ken added that the approach from FERCs perspective is a good one. Be careful that the studies that are being compared identifies the species and length of fish so an apples to apples comparison is made for Mason Dam. In regards to the number of fish being entrained, Ken thinks Nick is right, that entrainment is occurring with or without the project. From FERCs perspective if we are looking at percentage of mortality through the valve versus through the turbine that it would be ok because we don't need to look at the exact numbers because the numbers are not going to change with or without the presence of the project. The question is do the fish die or do they not die, that is what we are looking at. Ken does not see that the Mason

Dam project will have an influence on how many fish are being entrained so looking at straight percentages is effective.

Mike G. thought that Ken was correct that from current conditions to new project conditions that there will be no changes in entrainment. However, with Mason Dam there is a new project being fitted to that dam that there will be some level of mortality even if it is a fish friendly turbine.

Ken understood this and his understanding of Nick's proposal was to evaluate the mortality of the project and the current level of mortality based on existing studies through the valves and then do a comparison.

Randy asked if we be correct in assuming that if there was lower mortality or greater survival rates through the turbine that would be a positive that everyone would be pleased with or would we want fewer fish to survive into the lower river.

| Colleen stated that ODF&W would love to have a higher survival rate of red-band trout but we don't want the entrainment of yellow perch into the lower river.

Randy stated we want to save one species and kill another. He doesn't think there is a mechanical means to do that regardless of what we do. When looking at the existing situation there could be a greater survival rate through the turbine than the valves. Is that the result that everyone wants? Maybe because of the large numbers of perch in the reservoir we would want a lower number of survivability, just to ask the question, but Randy doesn't think we can pick and choose the species to survive and to kill on their trip through the turbine.

Alan stated that the reason of proposing a screen was that the fish don't actually leave the lake and they are left alive in the lake.

Randy understood this and stated, if the project is not built there will be a greater number of fish killed than if it is. Is that result good or bad?

Leslie added "One of the things Ken said is that we need to look at mortality when you are doing the literature review by species. What is the change in mortality, salmonids versus other fish, and it is variable by species and age class?"

Randy discussed the result of the Wickiup report in that if more fish are surviving is that more problematic to the process or is that the result that we want?

| Colleen stated that we want red-band trout survival, we don't want entrainment of the rainbow trout we stock in the reservoirs for put and take fisheries. We prefer not to lose those from the reservoirs which again would go toward screening, but the yellow perch (the non-native species) ODF&W does not want down in the river, so it is species specific.

Randy agrees with Nick that there is not a nexus to entrainment. If improvement to the lower river is by eliminating perch, screening would be one way to do that but is that now the responsibility of the project or is that something that ODFW would like to get done. Are there

other funds to do it? In regards to mitigation, are there mitigation measures that could be taken over the life of the project that would achieve some other goals that we would all be happy with other than screening the project now. Randy wants to put these things on the table in order that the direction this project needs to go can be determined.

Colleen stated that according to the Oregon state screening law, Baker County can go before the Oregon Fish and Wildlife commission with the proposal not to screen ~~that~~ as long as it is shown there is a net benefit to the game species which would include red-band trout. The expectation would be that if Baker County chooses to do this they would need to develop a proposal with mitigation measures and work with Colleen and ODFW ~~the~~ fish biologists, Tim and Nadine, who would review and provide comments.

Randy updated the stakeholders on the perch removal process that was conducted this spring by ODF&W, where over 300,000 perch were removed from the reservoir, in conjunction with Baker County. Randy's understanding is that this should be an annual process in order to be successful at keeping the perch numbers down. Currently it is funded for the next three years but then it will be reassessed. This is one of the things that goes through his mind that is there a way to turn this into a positive so we can continue to keep the perch down in the reservoir, provide better habitat for the native trout and the planted trout.

Ken asked Randy for clarification of turning this into a positive. Do you mean fund the perch removal as a mitigation measure.

Randy replied that it could be one since it would be for the life of the project versus just a three year process that if the funding is not renewed the perch population will explode after a couple of years as was the case when the Idaho Department of Fish and Wildlife harvested perch four to five years ago.

Ken thought this creative thinking will help in the development of the license application and proposals; however, we still need to know what the mortality effects are of the projects and then what are the management strategies of the agencies for the fisheries before we can get to that level thinking that you are at.

Nick asked Colleen if the yellow perch survive in the river long term or do they last until the winter and then they die and new ones wash through?

Colleen stated that she would need to talk to Tim but she thought that survival occurred, but was not that great.

(Colleen subsequently spoke with Tim who indicated there is survival and reproduction of yellow perch entrained through the project)

Randy also stated that he had not heard of a lot of fishermen catching them in the river.

Ken added that yellow perch may not orientate them selves near the intake since they like littoral zones of reservoirs.

Formatted: Font: Italic

Randy stated that in August when irrigation water is needed perch have been pulled through. Colleen stated that it is on the record that there has been observations of yellow perch entrained and it was discussed at the beginning of the project as one of the justifications to screen in lieu of the study.

“How are the bull trout being considered since they are a federally listed species and could potentially be entrained? Would providing a better chance of survival into the river be considered a positive from an endangered species stand point, compared to existing conditions?” asked Nick.

That is a question for Gary Miller stated Colleen. However, even if the turbine has less mortality than the valve, there could potentially still be take and a take analysis would need to be completed ~~and along with~~ an incidental take permit would probably be needed by the USF&W. ODF&W agrees that there are bull trout in tributaries that empty into Phillips Reservoir. They could be in the Reservoir and if they are, they are in small numbers. The intent of the endangered species act is to increase the population. If we are looking at potential mitigation measures in lieu of screening, measures for bull trout would be a priority.

Leslie asked “If any one has talked to Gary since the proposal to remove the screen was discussed last meeting?”

Colleen’s understanding from her conversation with Gary was that there was a screen proposal and in lieu of screening ~~and~~ there would be an entrainment study if there was not screen. If Baker County applied for a waiver from screening, ~~what should be done~~ Gary’s priority would be to see enhancement measures for bull trout completed above the project.

Mike G. added that the forest’s TES aquatic coordinator Carol, has left since the last meeting but in the conversation that Mike G. had with her after the last meeting, was that her preference would be to do upstream habitat improvement work for red-band and bull trout on the forest in lieu of screening.

Randy thought it was important that Nick do this study and be as specific as he can by species. It is also important to develop a mitigation plan to present with it so that things continue to move forward. His intent is that more would be done for the fish with mitigation than it would be to screen.

Mike H. added that part of the analysis would be what is being proposed as mitigation upstream so that in the future when project are being considered such as removing barriers the impacts have already been analyzed.

Ken asked “Does the Forest Service, ODF&W, and USF&W already have projects that they would like to see done in the upper Powder River basin?”

Colleen responded that Tim and Gary have a lot of ideas as well as Leslie who has given it a lot of thought.

“That may be some place to start for Baker County.” stated Ken.

The Forest is doing projects to improve fish passage, some implementation has occurred in some areas and it is known already what they want to do but it is moving from drainage to drainage and implementing the same strategy in those takes time. The work being done is primarily replacing culverts but there would be other things the Forest would be willing to work with the County on.

Marry added that once you get the exemption from ODF&W that it would help with the water right process. For the most part, the application used for FERC is used for the water right with the addition of the exemption from the fish and wildlife service if there is no screen. OWRD would also be happy to see the habitat restoration if it meets ODF&W needs.

PLP & DBA Comments

Baker County will continue to work on the mitigation measures and the costs associated with those. The development of the various plans such as the Weed Management plan, Re-vegetation Plan, and Erosion control measures that will be developed for the License application. Colleen asked if we were still looking at the November 31st date for submittal of the license application. Jason replied that the date was set as a goal but it will depend on the findings of the mortality study and the additional work needed. The agencies added that if it could be moved until after December it would be appreciated.

In closing, Joe discussed trying to determine the red-band trout spawning before the application is submitted.

Colleen stated that most of the time they spawn in April and May.

Ken asked “Could you look for emergence?”

Colleen stated that it would give you information for one year in a low flow year and a multi year study would be needed to really document it.

Randy added that for the DO, an evaluation of what the 95% would be for the area and is it really detrimental if the DO is at 9 or 9.5 versus 10 mg/L for 500 feet.

Colleen said this would be up to ODEQ but that she would also discuss this with Tim.

Mike G. added that as we go through this process as we look at the t-line info and mortality info provided, that through additional meeting, be it even a simple conference call, that the agencies could provide some help and information as the license application is being developed would be beneficial in which Ken added that FERC would strongly support this.

Items Baker County will continue to:

- Work with the F.S. over the current and potential road right of way for the t-line
- Work with the F.S. to obtain a SUA
- Work with the agencies to develop the tiered DO plan and DO compliance with a work window

- Develop a generation table from the past release history
- Develop plans and mitigation costs in consultation with agencies
- Complete paper study of mortality rates through valves and turbines similar to Mason Dam
- Collect a reference of management strategies and projects for fisheries and habitat improvements from agencies.



May 20th 2010 Meeting minutes

Jason Yencopal to: Audie Huber, Carolyn Templeton, Carl Stiff, Colleen Fagan, GRIFFIN Dennis, Emily Carter, Fred Warner, Gary Miller, Ken
06/25/2010 06:23 PM
Cc: Heidi Martin
Bcc: Jason Yencopal

From: Jason Yencopal/Baker County
To: "Audie Huber" <Audiehuber@ctuir.com>, "Carolyn Templeton" <Carolyn.Templeton@ferc.gov>, "Carl Stiff" <cbstiff@wildblue.net>, "Colleen Fagan" <Colleen.E.Fagan@state.or.us>, "GRIFFIN Dennis" <Dennis.Griffin@state.or.us>, "Emily
Cc: Heidi Martin/Baker County@Baker County
Bcc: Jason Yencopal/Baker County

Stakeholders,

Here are the long awaited and I am sure anticipated draft meeting minutes.

Have a great weekend,
Jason



May 20 2010 Work Session Minutes and exhibits.pdf

Mason Dam Work Session
May 20, 2010

Minutes

In attendance

Colleen Fagan – Oregon Department of Fish and Wildlife
Mike Gerdes – USDA Forest Service
Mike Hall – USDA Forest Service
Leslie Gecy – Eco West Consulting
Nick Josten – Sorenson Engineering
Ted Sorenson – Sorenson Engineering
Randy Joseph – Baker County
Jason Yencopal – Baker County

On the phone

Ken Hogan – Federal Energy Regulatory Commission
Joe Hassel – Federal Energy Regulatory Commission
Alan Richey – Oregon Department of Fish and Wildlife
Mary Grainey – Oregon Water Resources Department

Discussion Items

Transmission Line

Baker County, as discussed last meeting, was looking at other options of interconnection with Oregon Trail Electric Co-Op (OTEC) versus Idaho Power. Through continued discussions it does not look like the OTEC option will work. Ted added that the reason OTEC is not feasible is that the interconnection line does not have the “take away” capacity. Baker County will present its preferred method in the license application.

Mike G. asked if the original route that goes up Black Mountain Road is still going to be buried. Jason stated that the original proposed route is still being considered but Baker County is also looking at an overhead line due to the economics and habitat disturbance. Ted added that originally they were looking at a straight overhead route that required clearing trees because underground is expensive especially if the ground is rocky. Ted would like to work with the agencies to look at the option of zigzagging an overhead line up the Black Mountain road. Mike H. stated that the Forest Service’s preferred option would be underground. Mike H. understands that if technically the power can not go underground that is one issue. To which Ted replied that it is a lot of energy to put underground and Mike H. agreed that then this would be an issue that would need to be considered.

Mike G. wanted to clarify what Baker County would put in the license application. Would there be two proposals or would one be chosen and put in the license application? Ted said that one would be chosen and submitted in the license application.

Mike G. added, looking through the December meeting notes, that if the overhead is following the underground then the Forest Service will need to look at the Forest's Plan and the right of way restrictions because all the studies were based on an underground line versus an overhead line. Mike H. added that in the analysis the Bald Eagle Management Area (BEMA) would need to be considered if the line is overhead.

Nick thought that the information collected from the studies would be adequate enough to evaluate either option but Baker County has not evaluated the overhead option. Mike H. stated the only thing not addressed with the underground option was the BEMA.

There was some discussion on the eagle nest and the distance from the road and the BEMA boundary. Leslie clarified that the edge of the BEMA is the West edge of Black Mountain Road.

Mike G. said technically if the overhead line stays outside of the BEMA it would meet the bald eagle needs and it would also meet a lot of our concerns of the underground line going through riparian areas. The question that the FS would need to answer is what the current right of way is and what additional clearing would have to occur for an overhead transmission line.

Mike G. agreed with Nick that information from the studies should be able to evaluate the overhead line and added that from a cultural standpoint that if Baker County has cultural clearance then drilling new holes for the poles could be an option. Mike H. added that if Baker County is going to be following the same line then there will be less disturbance than digging a line up the whole road.

A question arose about who would be issuing the authorization for the power line, FERC or F.S. Since it is in the project boundary, FERC would be authorizing the transmission line and no special use permit would be issued by the F.S. Ken's understanding was that the F.S. would still issue special use permits for FERC licensed hydropower projects. Mike G. stated that he would check on the dates of issuance versus non issuance but his understanding is that even on new projects because we are past 1976 we don't need to issue any new SUA (Special Use Application) if it is in the FERC Project Boundary.

In an e-mail from Mike Gerdes to Ken and myself dated June 1, 2010, Mike found the following:

*The Energy Policy Act of October 24, 1992 amended the Federal Land Policy and Management Act of October 21, 1976 and specified that a SUA is not required for any existing project, whether licensed or granted and exemption that was not subject to a permit under the FLPMA prior to October 24, 1992. However, a SUA is required for all **NEW** hydro project proposed after October 24, 1992. As Mason Dam is a new project it will be required to obtain a SUA from the FS.*

Ken wanted to clarify that the proposed interconnection at the base of the dam is no longer an alternative. In which Ted replied "That is correct."

Baker County will provide a typical pole detail that will comply with the avian manual as well as the clearance needed based on what we would like and what is needed.

Leslie asked what the height and spacing of the poles would be. Ted thought it would look similar to the distribution lines currently in the area, the spacing will depend on the zigzag of the road. If it was a straight line the poles could be spaced 500 feet apart. An estimated spacing would be 300 – 500 feet. Randy added the height would be around 35 to 40 feet.

Dissolved Oxygen

Current Water Quality Standards are:

From January 1 to May 15 are the salmonid spawning requirements of 11.0 mg/L or 95% saturation.

From May 16 to December 31 is 6.5 mg/L.

In the December meeting Paul DeVito originally ruled out the original phased DO plan of draft tube aeration, bypass release, and rock weirs. Since this time Paul called and discussed moving the compliance point down stream to site 4 as defined in the Water Quality Study which is just downstream of the stilling basin (.05 miles exhibit 7). Baker County discussed having two compliance points one being for the 6.5 mg/L standard and the other for the 11.0 mg/L or 95% saturation standard (.16 miles exhibit 8). Leslie will discuss the information that Baker County used to consider two compliance points. Leslie described that during the T&E TES species survey, aquatic invertebrates were looked for in the reach from the dam down to the gauging station. The study was done in October due to low releases so that the sub straight could be examined. The sub straight consists of mostly boulders and very few fines in that stretch. The study was not for spawning but while looking for mussels it was determined that there was no habitat because there was nothing for them to burrow into and aquatic invertebrate habitat would be limited for the same reason, lack of sub straight.

Colleen informed us that when Paul called and discussed the compliance point with her and Tim Baily, the district fish biologist, that Paul also asked about the extent of red band trout spawning habitat. For ODFW it is right up to the stilling basin based on the observations of the planted salmon attempting to spawn in that area.

Leslie asked when the spawning activity had been observed. Colleen stated that she had not personally observed this but Tim Bailey had from monitoring the salmon activity. Leslie wanted to clarify the location as the habitat really changes below the gauging station. Colleen said that she will have to talk with Tim more but in their conversations Tim's expectation would be that the compliance point be up at the end of the stilling basin. Randy wanted clarification that these observations were from the salmon that had been released by ODFW for anglers to fish for, to which Colleen affirmed. Nick asked Leslie if there was habitat information on the stream channel and would we be able to look at the spawning requirements for red band and compare that to the existing mapped habitat to make a determination as to whether there appears to be suitable habitat. Leslie would like to talk to Tim and see exactly where he saw them spawning and discuss his observations.

Ken asked "If it is documented that there is spawning up to the stilling basin does that effect your proposal?" The answer to that question is yes, according to Ted. The reason is that in May the water has around 9 – 10 parts per million naturally. In order to reach 11.0 it is approaching

saturation or super saturation depending upon the location (elevation and temperature). To do this by mechanical means becomes very difficult, theoretically it is impossible to do this so Ted always looks for natural means of aeration with boulders and distance. It is getting from 9.5 to 11 that is very difficult. The .16 miles is very valuable so that you can use natural means to reach saturation.

Ken asked how often the project would operate during the stricter criteria. Ted discussed that the irrigation season that will vary from year to year but in Jan – March on most years there will be the minimal discharge of 10 cfs but irrigation season may start in April or May depending on the run off. Jason gave the example for this year releases on May sixth they were releasing 19 cfs, May twelfth 63 cfs, May thirteenth 202 cfs. The project is designed to generate as low as 100 cfs and would have only been able to operate May 13, 14, and 15. There are years depending on the snow pack and rain fall that increase flow could occur in April and May to ensure the reservoir does not overflow.

ODEQ

Jason wanted to update the stakeholders with the information that Paul DeVito had accepted a different position and would no longer be working on the Mason Dam project. Baker County has not heard who would be taking on Paul's duties at this time.

In an e-mail received from Paul DeVito on 6/24/2010 it has yet to be determined who will cover some of the hydro projects he was working on.

Phased DO Plan

Before Paul left for his new position he had discussed on the phone with Jason the possibility of adding rock weirs as an option since the compliance point had been moved downstream. Before moving on Nick wanted to clarify with Colleen that the need to establish a basis for determining where spawning occurs and the principle behind moving the compliance point downstream to where spawning occurs is because of the standard that applies to spawning and if that makes sense. Colleen stated that she understood that but we would need to talk to Tim to have a better understanding of where the spawning is occurring, and if there is spawning in that reach it would not apply.

Draft Tube Aeration

Up until May 15 the higher DO standard would be in affect, and then after May 15 the standard is 6.5 mg/L. Usually most reservoirs you have 6.5 and Ted questioned Mason Dam being low until reviewing the data.

Ted discussed the design of the turbine layout. The turbine has been changed from a vertical shaft to a horizontal shaft and this changed the water being discharged from the turbine into the draft tube above the tail water level. This creates a venturi effect that once you open a valve air naturally enters the pipe turning the draft tube into an aerator. Generally the DO can be raised from 2 parts per million to 6 or 7 parts per million, with draft tube aeration very naturally. If the standard is not met then the turbine would be shut down and the water would exit through the

existing valves. There would also be times where the discharge would be a mixture from turbine and existing valves. The plan to meet the 6.5 mg/L would be to use the draft tube aeration along with bypass flows when needed to meet standards.

(In the meeting, Ted mentioned shutting off the turbine completely and going just with the existing valves if the standards are not being met. To clarify, we would first start bypassing flows through the existing valves while still operating the turbine. The amount of bypass would change depending upon the results. If the bypass flows require so much cfs that the cfs diverted to the turbine is lower than 100 cfs then the turbine will be shut down.)

Ted explained that mechanical aeration would consist of motors and pumps much like sewer lagoons that are not as reliable and are expensive. The issue with approaching saturation for the January 1st through May 15th standard is that if .16 miles is allowed natural aeration of the existing channel and of use rock weirs can augment the DO to meet the standard. Rock weirs can also add fish habitat and look very nice once completed. To meet the high standard of 11.0 mg/L or 95% saturation we want to use the draft tube aeration, bypass flows, natural aeration of the stream augmented with rock weirs if needed, would be used.

Colleen asked what other options are available if the compliance point is not moved down .16 miles.

Ted said the next option would be to install a labyrinth weir, made of concrete and steel, in the stilling basin (see exhibit 9). This type of weir is more expensive than a rock weir.

Mary would like to see a photo of the rock weir and some estimates of increased habitat that could be created.

Ted has built a rock weir on the Tiber project in a “V” because of the concern of bank erosion. The weir does not necessarily have to be a “V” but could be an arch or straight line (see exhibit 10).

Ken added that his recollection of this section of Powder River has a series of rock weirs across it for habitat.

Leslie thought there has been some rock weirs placed in the stream done by the Forest Service.

There is not really a rock weir per say but boulders have been placed in a random fashion from the stilling basin to the gauging station. See exhibit 11 for a photo.

Randy asked if the existing river is not adequate to meet the needs.

Ted would like to do a phased approach as was negotiated at the Tieton project where it is being monitored and if the standard is not being met then the rock weirs will be added.

Randy wanted to clarify that the rock weirs would come later in the project and not up front, which was the correct understanding.

Ken asked that under a phased approach, is it the proposal that at any point in time in the monitoring that the project does not meet the standard you would shut down and go through the valves.

Ted's reply was yes in this case up until May 15th as long we had assurance that we could put the rock weirs in forth with so we did not have to be shut down for more than one season. We would be in trouble economically and that seems reasonable to him.

See previous comments on shutting off the turbine

Colleen stated that the project will need to meet standards and if it does not, it can not continue to operate.

Ted described that on a project in Washington that if they did not meet the equivalent of 11.0 but are between 9.5 and 11.0 they were given a grace period of one year to then install the rock weirs. If they were below 9.5 then the project would need to be shut down. Ted thought that in this case of Mason Dam that it would be reasonable to give a range that the project needs to operate in and then install the rock weirs the next year if it is not meeting the standard.

Mike G. stated that from a Forest Service/NEPA stand point we would like to see the rock weirs analyzed as the preferred alternative. This way if the rock weirs are needed the Forest Service could say go ahead and install them. If the rock weirs are not included in the original plan then a separate NEPA analysis would have to be done to evaluate the addition of the rock weirs.

Colleen added that a lot of this is going to depend on what Oregon DEQ allows and we need to keep in mind that the red band trout is a sensitive species.

Nick clarified that from a project standpoint that if the project had an emergency to shut down due to a DO issue, some assurance would be needed that the project could then fix the problem and start back up. Ted added that we will need a plan B set ahead of time. Mike G. added that as part of the monitoring plan that plan B, the installation of rock weir, and have that analyzed up front, this way there would not be a separate analysis for installation.

Joe in considering the releases made this year and that how little impact that would of happened this year because the releases did not come up to where generation could occur but only a couple of days before May 15th asked, is there any way to estimate how much energy would be lost if the project could not generate before May 15th? Ted stated that in hydro the past is the future and that by looking at the past hydrology of 20 years that it could be analyzed. Joe agreed with Ted's statement about the past being the future in hydro.

Nick stated in the PLP, the existing data was compiled and the flows averaged 100 cfs in April and could not be written off. Ted added that April could be written off in any given year but year in and year out it could not and that is why we are looking at these rock weirs.

Ken asked that if it is determined that spawning does occur up to the dam, there would not be much head for the rock weirs to work, what does this do to the tiered plan.

Ted replied that it would make things difficult. Randy added that in that case plan b would be to use a labyrinth weir, to which Ted agreed.

Ken asked if there was a way to model the DO from the draft tube based on the monitoring that had been completed.

Ted for an example said lets look at early May this year and asked Jason what had been recorded with the reply being 9.91 mg/L. In Ted's book 9.91 is saturation or pretty close, 11.0 or higher is possible but not through mechanical means. The driving force needed to drive oxygen into solution is divided by the difference between saturation and the current reading, equaling a very small driving force. The only way to do this is naturally where you have distance and time to do it. Randy wanted to clarify that the standard is 11.0 mg/L **OR** 95% saturation, correct? At this location and elevation isn't the DO percent a function of elevation and temperature, so what would 95% saturation be at 3900 ft and 50 degree water temperature. Jason added that one reading he took was that the mg/L was 10.05 and the percent saturation was 95.1%. Randy stated that maybe we are a lot closer than we think we are, because 11.0 is probably to great of a number for this elevation and water temperature. Ted suspects that we are going to be very close but it is that very close to being there and it is that last little bit to get there by mechanical means that is very very difficult. Ken asked that based on what was discussed earlier that the draft tube aeration would raise the DO 2-4 points, would that not be enough? Ted replied that as saturation is reached the draft tube aeration is not as effective. Ken understood this but thought it could improve the situation from 9 to 10. Ted added that the draft tube aerator could not be counted upon to improve the DO from 9 to 10 but instead 9 to 9.4. As it gets close to saturation that last 5% gets to be very difficult. From Ted's research he has not found any documentation where draft tube aeration working near saturation, where they shine is in the 4 to 6 or 0 to 4 mg/L range.

Fish Screen

Baker County's original understanding was that the study proposed, the entrainment study, and the fish screen were going to roughly be the same cost, \$250,000. So Baker County looked at the study and regardless of the findings it looked like the outcome could potentially be to screen. So the County looked at spending \$250,000 once versus twice and this is where the proposal of screening the intake originated. Randy added that when we first started the project he had done most of the analysis, and the entrainment study was very difficult to do. The suggestion from ODF&W was to use rotary screw traps. These would not work in our river system since it was too small. Also the fact that what ever the entrainment was determined, it still did not address could a bull trout come down stream and go through the project and be hurt in some fashion and would that be a problem. There was not an absolute given. Even if the findings were there was not a problem with entrainment, that we could get the result that we were after and that was the most confusing part that even if the study was done we would still not have any definite conclusion that we could not screen. Ted has brought a lot more information forward since the time of the original proposal.

Colleen wanted to clarify the history as ODFW understands it. In lieu of conducting an entrainment study Baker County proposed to screen. If screening did not occur then an entrainment study would occur as found in the study plan.

Mike G. also stated that his understanding was also that screening was in lieu of the entrainment study and if there was no screen then the County would go fourth and do the study.

Nick agreed with these statements and added that what we have done is changed the proposal. What we propose now is a hydroelectric project without a screen. The impact analysis done over the last year and a half or so has not taken this into account. So now we need to address the impact of building a project without a screen. Baker County proposes to look at this. It involves entrainment and mortality of fish. The entrainment is not going to change since the water is going to be withdrawn in the same amount as it always has been through the same intake, the same number of fish will be entrained as there has been historically. So there would be no change, screen or no screen, actually there would be a change if there was a screen there would be no entrainment. Colleen agreed that there would be no entrainment if there was a screen. Nick clarified that there would be no entrainment compared to existing conditions. So what it comes down to is mortality. How do we want to address this, discuss why the screening is probably a project killer, or address the fact that we have changed the proposal? Ted wanted to address why the screen is a project killer. It is not impossible to put a screen on this deep intake from an engineering standpoint but it is economically impossible. It would cost more than the plant to do. In Ted's research and experience, building three projects on BOR dams two of which are similar to Mason Dam, searching all the way up into the Montana region or Boise region, he has not found any projects with submerged screens. Jason had found some screened projects in Oregon; these are primarily irrigation system and around 75 cfs versus 800 cfs. We would have to build a tower around this intake to mount the screens to and be able to pull them out for cleaning. He also called Steve Craimer and Associates out of Gresham and asked if they had run across any of these deep intake screens. They were not aware of doing this, there may be one or two out there but it is not a common thing. Irregardless of the common thing it is an economic deal killer, if there is to be fish screen on this project. Alan stated that he had not heard a cost estimate for the screens. Hendrick screen had contacted him yesterday or the day before and was not sure if they have supplied an estimate. Jason has been working with Hendrick's to get a cost estimate and recently called to check on the estimate in which they must have called Alan to get the specifics for the screen. Alan talked to him this week and reminded him that no fry are present which would cut the cost of the screen in half. Ted stated that he was not basing the cost of the screen on the screen as the cost would be nominal, but the cost is based on the cost of the tower and the fact that you can not fully dewater the reservoir to construct the tower. Randy added that when he originally bid the screen from Hindrick's it was probably based on to low of a cfs number and did not take into consideration the emergency aspects and dewatering the reservoir, that is why there is such a price difference in what was originally proposed. Alan asked for clarification about the 800 cfs. Jason responded that the max release of Mason Dam is 875 cfs through the outlet works, not over the spillway. The spillway has never been used at Mason Dam. The project is designed for a maximum of around 300 cfs. Alan asked what was the flow design given to Hendricks. Jason said that if the screens were built over the existing intake that they would have to pass the full 875 cfs, however if there was

some sort of emergency bypass valve that could be opened and separate from the screens then all the project would need would be a screen based on 300 cfs.

Ken asked for an explanation for the need of the tower and why some sort of steel super structure could not be placed on top of the intake that came to the surface. Ted replied that a separate structure would be needed for a way to access the screens for maintenance and operation.

Alan discussed that in other situations they have installed similar screens as the Johnson folks and had screens that were on rails so the screens could be put in place and taken out for maintenance. Ted understood this and added that the rails would still need a tower super structure to mount to which would be up to 100 feet tall and something to set it on. Alan added that you may not have to necessarily go straight up and down but could angle it up to the shore. Jason commented on the current intake and information received from the Shawn Foster who was working on the bids from Hendrick's. He was saying that what ever our screen would be we would need a buffer of half the screen width for the airburst system to clean the screen. With the current intake if we tried to put something on it there would not be enough room from the sill to the dirt and we would also have to be out of the silt line because there is no sweep velocity so we would need a tower of some sort. Alan would like to see what the estimate would be when it is complete. Randy stated that he had one concern, that the Bureau of Reclamation has not given their input on this and they would have the final say on this. Ken asked if the Bureau of Reclamation has been consulted on the screen design for Mason Dam. In which both Ted and Jason answered we have been talking and working with them. Ted continued by saying that he has been talking to them. The Bureau wants to know what is going to be done about plugging the screens and what steps are going to be taken so they don't plug. From experience with dealing with the BOR it is not inexpensive because they have very high standards.

Ken stated that it sounds like the next step is to figure out the actual screen costs versus the alternatives. In which Alan added that this would also be his suggestion.

Mike G. asked how big is the intake structure of Mason Dam. Jason showed the group exhibit 5 and added that the dimensions are 17' wide and deep and 13' high. Additional discussion took place over the possible railroad tracks down to the intake and the depth of the intake which varies due to water level. Jason will provide numbers of the data. In 2007 when the water quality study was done, it was declared a drought year.

Ken clarified that regarding the cost for the original screen was \$250,000. How much more is it and what is the magnitude.

Alan asked if Jason was expecting a proposal from Hendricks. Yes, but that will be just for the screen. Alan added that they would not be quoting the tower structure. In which Jason added that they would not. BOR is going to provide him with information from two of their projects pumping projects that they did add screens to ten years ago. Brewster 47 cfs and East Unit 75 cfs, both of these projects have the rail system and a depth of around 25 feet. The difficult part about these projects is finding a location where there was some sweep velocity so that when the screens air burst the debris was swept away, they were not able to work in the dry bringing in divers and cranes. Nick added that in these projects the screens could be removed for the

irrigators to receive their water. For Mason Dam he would imagine the process would be lengthy with BOR to ensure that the water flow is not disrupted and what kind of back up is available. Nick added that he found three BOR projects in the Bend area with the deepest being 55ft, one with rails down the dam to the intake and the other two with tower intakes.

In an e-mail received from Shawn Foster, who was working to get a quote from Hendricks, on 6/22/2010 stated:

The screens are perforated plate, sorry, we won't be quoting them.

Ken asked Nick about the screen proposal and identifying the issues to propose an approach to move forward. Nick added that Baker County is going to build a hydro project without a screen and that impact has not been evaluated. The two elements of the impact are the entrainment and mortality of the fish going through the outlet works. The entrainment will not change from existing conditions. For mortality, the work that needs to be done is evaluating the mortality of fish going through the existing gate valve versus a Francis turbine. Work has begun in looking at a paper study for turbine mortality that was presented in the PLP and that is what would be used to estimate the turbine mortality and we would update that with new studies that have been done in the last ten years of similar projects. The estimate of mortality through the existing system has not been done at all and the proposal would be to also conduct a paper study based on mortality studies done at other locations with similar valves. Nick has started conducting this study and there are some studies available, not a lot of them but some. From his understanding of these studies the type of valve makes a big difference. If it is a type of valve that places a blockage over the flow in the conduit it creates a surface for fish to strike against, creates a low pressure zone where cavitations occurs, and these tend to be very hard on fish, which is similar to Mason Dam's valve that lowers a gate into the flow. The other type of valve is something like a clamshell valve that shapes the orifice and make it larger or smaller but keeps it uniform and these valves tend to keep the water in stream line flow they don't have anything in the middle for the fish to strike against and have lower mortality. The proposal would be to continue to locate all the information we can find on these types of valves and make a comparison to the valves at Mason Dam and base our estimate of mortality from these studies. Because these are estimates and there may be some uncertainty in the results more may need to be done, however, from a study that was conducted at Tieton Dam in Washington the results were so far apart that a general assessment could be made. So the proposal would be a phased approach that a paper study be done and then determine if more is needed.

Ted said he thinks it would be similar to Tieton in which there was a 90% plus mortality rate. Mike G. also added that while we are gathering data to look at Bowman Dam near Prineville Oregon. There is a lot of escapement with a lot of survivability of trout coming through; however they have a lot of gas bubble disease. Nick then talked about the study for Wickiup Dam because it was found that the survival rate through the turbine was greater than the valves and the fish being passed could be a detriment to the river below. It has been documented that in some cases turbines are easier on fish than valves. Mike G. asked if Francis turbines are the turbines proposed at Wickiup Dam. It was not sure of the type of turbine at Wickiup, possibly a Kaplan but a Francis is being proposed at Mason Dam.

So the proposal for impact analysis of no screen is to look at similar projects with valves, similar projects with turbines and make an assessment based on the findings.

Alan asked if our expected outcome of mortality would be lower with the proposal at Mason Dam, in which Nick replied yes. Alan continued that you will still have x percent mortality, how will you know how many fish will be entrained at this site. Some things can relate from project to project when the equipment is similar but the actual lake and the fish populations will not be similar, how will actual entrainment numbers be captured. Nick replied that we will not, we will say that the current entrainment is X and it will still be X after the project is installed and so it is nothing that we have any affect on.

“So what you are saying is that if the mortality goes down, then the project is not having any affect?” asked Colleen.

Nick responded that there would be more fish surviving down into the river than is currently the case, how many more, we could not say but there are more than before.

Colleen added that we would not know how many fish are being killed, what the population impacts are, or how it relates to fish species and size of fish, or other factors which would be a concern if we don't get down to those specifics to help determine what the impacts would be on the native population. On this project what we are looking at would be non native fish passage into the Powder River and we are talking about yellow perch.

Nick responded that all we could say is that there would be more fish surviving.

If the case is being made for the project not to screen, Alan's expectation is that there would be some sort of mitigation being proposed at some point based on the number of fish being killed at this site.

When Nick does these analyses, he bases them on existing conditions as the base line that we are measuring impacts relative to. In this case, if more fish are surviving once the project is completed than before, then there would be no negative impact unless it is a case such as Wickiup where they don't want the fish to survive.

Alan will have to look into that scenario; it looks like there is still an unknown number of fish being killed as a result of the project that we will not have a handle on.

Ken added that the approach from FERCs perspective is a good one. Be careful that the studies that are being compared identifies the species and length of fish so an apples to apples comparison is made for Mason Dam. In regards to the number of fish being entrained, Ken thinks Nick is right, that entrainment is occurring with or without the project. From FERCs perspective if we are looking at percentage of mortality through the valve versus through the turbine that it would be ok because we don't need to look at the exact numbers because the numbers are not going to change with or without the presence of the project. The question is do the fish die or do they not die, that is what we are looking at. Ken does not see that the Mason Dam project will have an influence on how many fish are being entrained so looking at straight percentages is effective.

Mike G. thought that Ken was correct that from current conditions to new project conditions that there will be no changes in entrainment. However, with Mason Dam there is a new project being fitted to that dam that there will be some level of mortality even if it is a fish friendly turbine.

Ken understood this and his understanding of Nick's proposal was to evaluate the mortality of the project and the current level of mortality based on existing studies through the valves and then do a comparison.

Randy asked if we be correct in assuming that if there was lower mortality or greater survival rates through the turbine that would be a positive that everyone would be pleased with or would we want fewer fish to survive into the lower river.

Colleen stated that ODF&W would love to have a higher survival rate of red band trout but we don't want the entrainment of yellow perch into the lower river.

Randy stated we want to save one species and kill another. He doesn't think there is a mechanical means to do that regardless of what we do. When looking at the existing situation there could be a greater survival rate through the turbine than the valves. Is that the result that everyone wants? Maybe because of the large numbers of perch in the reservoir we would want a lower number of survivability, just to ask the question, but Randy doesn't think we can pick and choose the species to survive and to kill on their trip through the turbine.

Alan stated that the reason of proposing a screen was that the fish don't actually leave the lake and they are left alive in the lake.

Randy understood this and stated, if the project is not built there will be a greater number of fish killed than if it is. Is that result good or bad?

Leslie added "One of the things Ken said is that we need to look at mortality when you are doing the literature review by species. What is the change in mortality, salmonids versus other fish, and it is variable by species and age class?"

Randy discussed the result of the Wickiup report in that if more fish are surviving is that more problematic to the process or is that the result that we want?

Colleen stated that we want red band trout survival, we don't want entrainment of the rainbow trout we stock in the reservoirs for put and take fisheries. We prefer not to lose those from the reservoirs which again would go toward screening, but the yellow perch (the non-native species) ODF&W does not want down in the river, so it is species specific.

Randy agrees with Nick that there is not a nexus to entrainment. If improvement to the lower river is by eliminating perch, screening would be one way to do that but is that now the responsibility of the project or is that something that ODFW would like to get done. Are there other funds to do it? In regards to mitigation, are there mitigation measures that could be taken over the life of the project that would achieve some other goals that we would all be happy with

other than screening the project now. Randy wants to put these things on the table in order that the direction this project needs to go can be determined.

Colleen stated that according to the Oregon state screening law, Baker County can go before the Oregon Fish and Wildlife commission with the proposal not to screen that as long as it is shown there is a net benefit to the game species which would include red band trout. The expectation would be that if Baker County chooses to do this they would need to develop a proposal with mitigation measures and work with Colleen and the fish biologist, Tim and Nadine, who would review and provide comments.

Randy updated the stakeholders on the perch removal process that was conducted this spring by ODF&W, where over 300,000 perch were removed from the reservoir, in conjunction with Baker County. Randy's understanding is that this should be an annual process in order to be successful at keeping the perch numbers down. Currently it is funded for the next three years but then it will be reassessed. This is one of the things that goes through his mind that is there a way to turn this into a positive so we can continue to keep the perch down in the reservoir, provide better habitat for the native trout and the planted trout.

Ken asked Randy for clarification of turning this into a positive. Do you mean fund the perch removal as a mitigation measure.

Randy replied that it could be one since it would be for the life of the project versus just a three year process that if the funding is not renewed the perch population will explode after a couple of years as was the case when the Idaho Department of Fish and Wildlife harvested perch four to five years ago.

Ken thought this creative thinking will help in the development of the license application and proposals; however, we still need to know what the mortality effects are of the projects and then what are the management strategies of the agencies for the fisheries before we can get to that level thinking that you are at.

Nick asked Colleen if the yellow perch survive in the river long term or do they last until the winter and then they die and new ones wash through?

Colleen stated that she would need to talk to Tim but she thought that survival was not that great.

Randy also stated that he had not heard of a lot of fishermen catching them in the river.

Ken added that yellow perch may not orientate themselves near the intake since they like loral zones of reservoirs.

Randy stated that in August when irrigation water is needed perch have been pulled through. Colleen stated that it is on the record that there has been observations of yellow perch entrained and it was discussed at the beginning of the project as one of the justifications to screen in lieu of the study.

“How are the bull trout being considered since they are a federally listed species and could potentially be entrained? Would providing a better chance of survival into the river be considered a positive from an endangered species stand point, compared to existing conditions?” asked Nick.

That is a question for Gary Miller stated Colleen. However, even if the turbine has less mortality than the valve, there could potentially still be take and a take analysis would need to be completed along with an incidental take permit would probably be needed by USF&W. ODF&W agrees that there are bull trout in tributaries that empty into Phillips Reservoir. They could be in the Reservoir and if they are, they are in small numbers. The intent of the endangered species act is to increase the population. If we are looking at potential mitigation measures in lieu of screening, measures for bull trout would be a priority.

Leslie asked “If any one has talked to Gary since the proposal to remove the screen was discussed last meeting?”

Colleen’s understanding from her conversation with Gary was that there was a screen proposal in lieu of screening and there would be an entrainment study if there was not screen. If Baker County applied for a waiver from screening what should be done. Gary’s priority would be to see enhancement measures for bull trout completed above the project.

Mike G. added that the forest’s TES aquatic coordinator Carol, has left since the last meeting but in the conversation that Mike G. had with her after the last meeting, was that her preference would be to do upstream habitat improvement work for red band and bull trout on the forest in lieu of screening.

Randy thought it was important that Nick do this study and be as specific as he can by species. It is also important to develop a mitigation plan to present with it so that things continue to move forward. His intent is that more would be done for the fish with mitigation than it would be to screen.

Mike H. added that part of the analysis would be what is being proposed as mitigation upstream so that in the future when project are being considered such as removing barriers the impacts have already been analyzed.

Ken asked “Does the Forest Service, ODF&W, and USF&W already have projects that they would like to see done in the upper Powder River basin?”

Colleen responded that Tim and Gary have a lot of ideas as well as Leslie who has given it a lot of thought.

“That may be some place to start for Baker County.” stated Ken.

The Forest is doing projects to improve fish passage, some implementation has occurred in some areas and it is known already what they want to do but it is moving from drainage to drainage and implementing the same strategy in those takes time. The work being done is primarily

replacing culverts but there would be other things the Forest would be willing to work with the County on.

Marry added that once you get the exemption from ODF&W that it would help with the water right process. For the most part, the application used for FERC is used for the water right with the addition of the exemption from the fish and wildlife service if there is no screen. OWRD would also be happy to see the habitat restoration if it meets ODF&W needs.

PLP & DBA Comments

Baker County will continue to work on the mitigation measures and the costs associated with those. The development of the various plans such as the Weed Management plan, Re-vegetation Plan, and Erosion control measures that will be developed for the License application. Colleen asked if we were still looking at the November 31st date for submittal of the license application. Jason replied that the date was set as a goal but it will depend on the findings of the mortality study and the additional work needed. The agencies added that if it could be moved until after December it would be appreciated.

In closing, Joe discussed trying to determine the red band trout spawning before the application is submitted.

Colleen stated that most of the time they spawn in April and May.

Ken asked "Could you look for emergence?"

Colleen stated that it would give you information for one year in a low flow year and a multi year study would be needed to really document it.

Randy added that for the DO, an evaluation of what the 95% would be for the area and is it really detrimental if the DO is at 9 or 9.5 versus 10 mg/L for 500 feet.

Colleen said this would be up to ODEQ but that she would also discuss this with Tim.

Mike G. added that as we go through this process as we look at the t-line info and mortality info provided, that through additional meeting, be it even a simple conference call, that the agencies could provide some help and information as the license application is being developed would be beneficial in which Ken added that FERC would strongly support this.

Items Baker County will continue to:

- Work with the F.S. over the current and potential road right of way for the t-line
- Work with the F.S. to obtain a SUA
- Work with the agencies to develop the tiered DO plan and DO compliance with a work window
- Develop a generation table from the past release history
- Develop plans and mitigation costs in consultation with agencies
- Complete paper study of mortality rates through valves and turbines similar to Mason Dam

- Collect a reference of management strategies and projects for fisheries and habitat improvements from agencies.

Exhibit 1

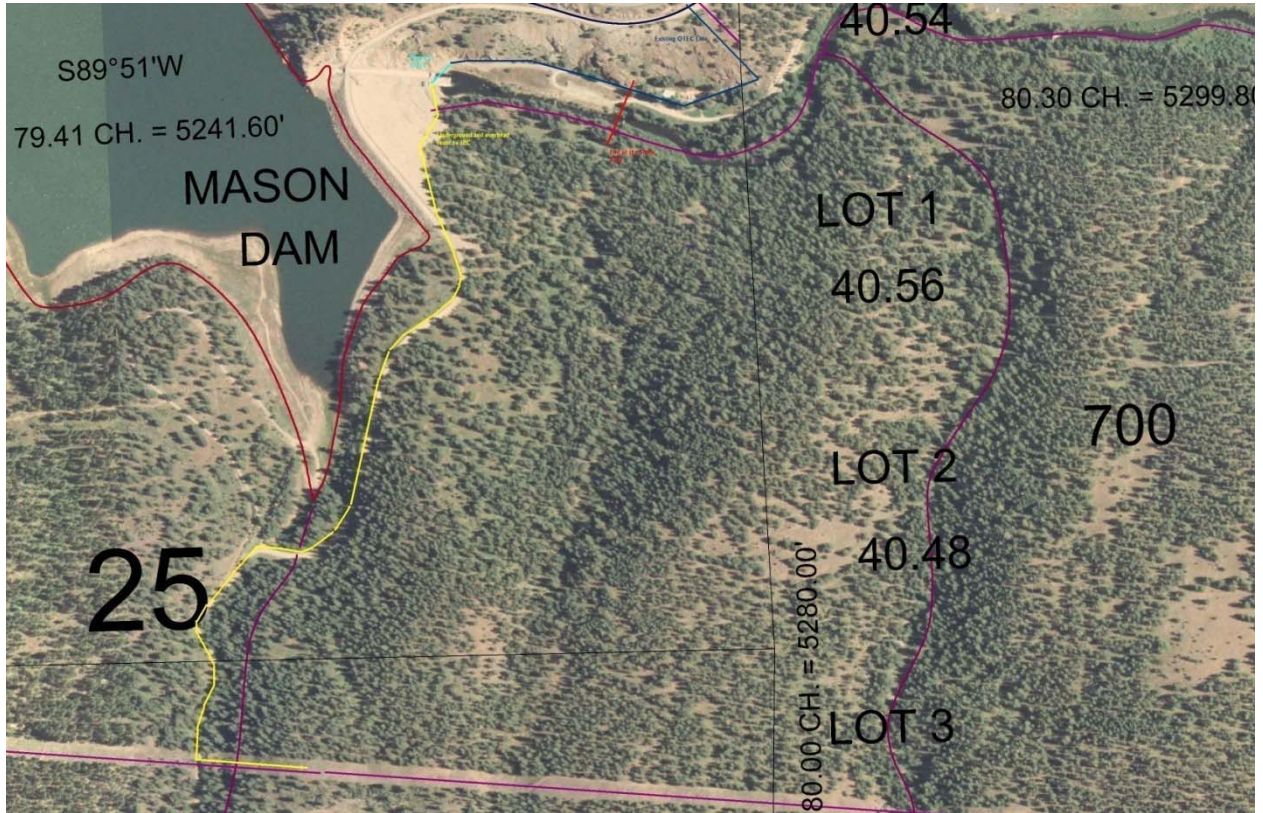

Exhibit 2

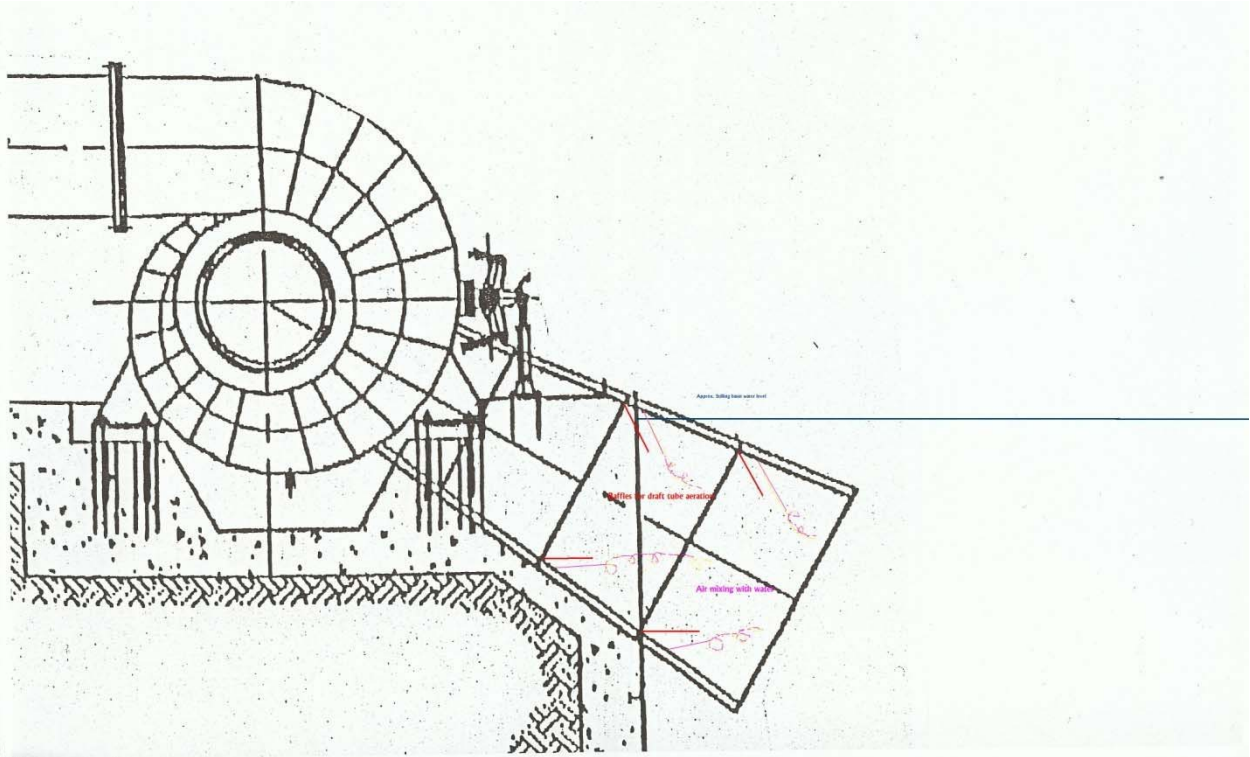

Exhibit 3



Exhibit 4

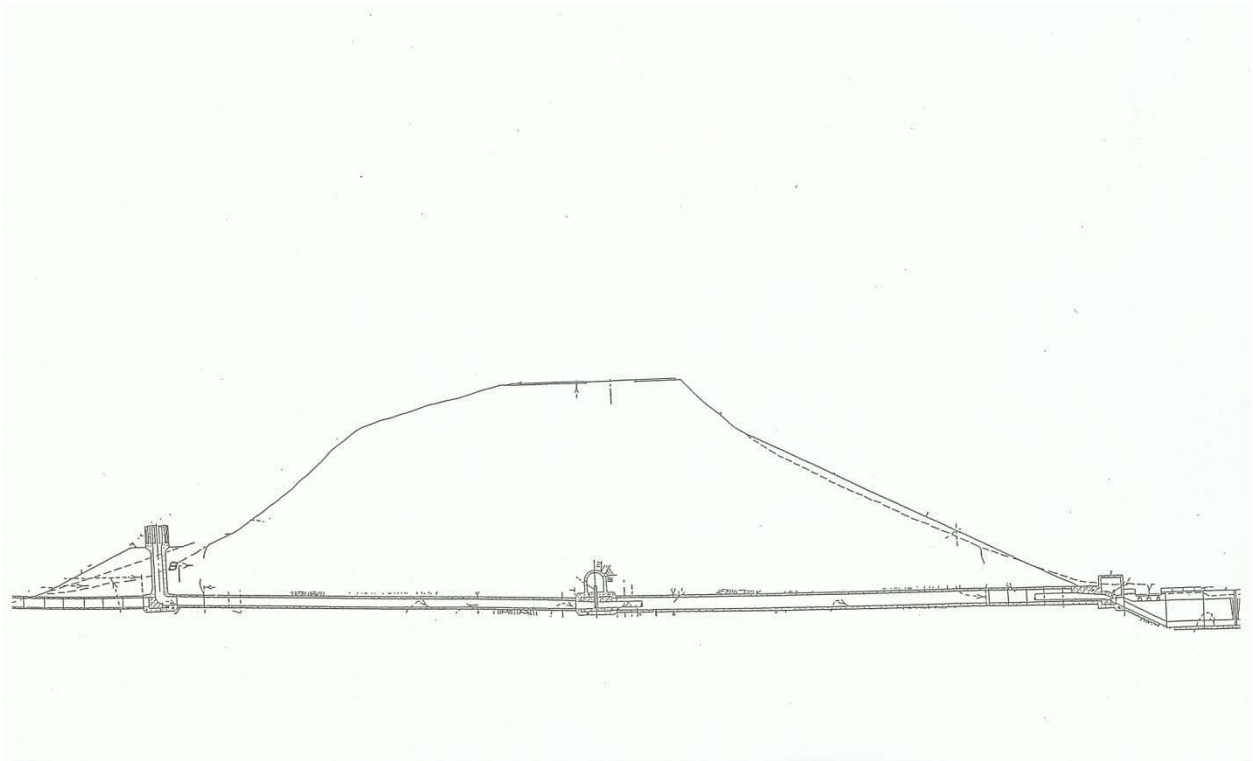

Exhibit 5



PHOTOGRAPH NO. II-5. MASON DAM, BAKER PROJECT, OREGON.
Intake structure with hinged top trashrack.

Exhibit 6



Exhibit 7 - .05 miles down stream



Exhibit 8 - .16 miles down stream



Exhibit 9



Exhibit 10

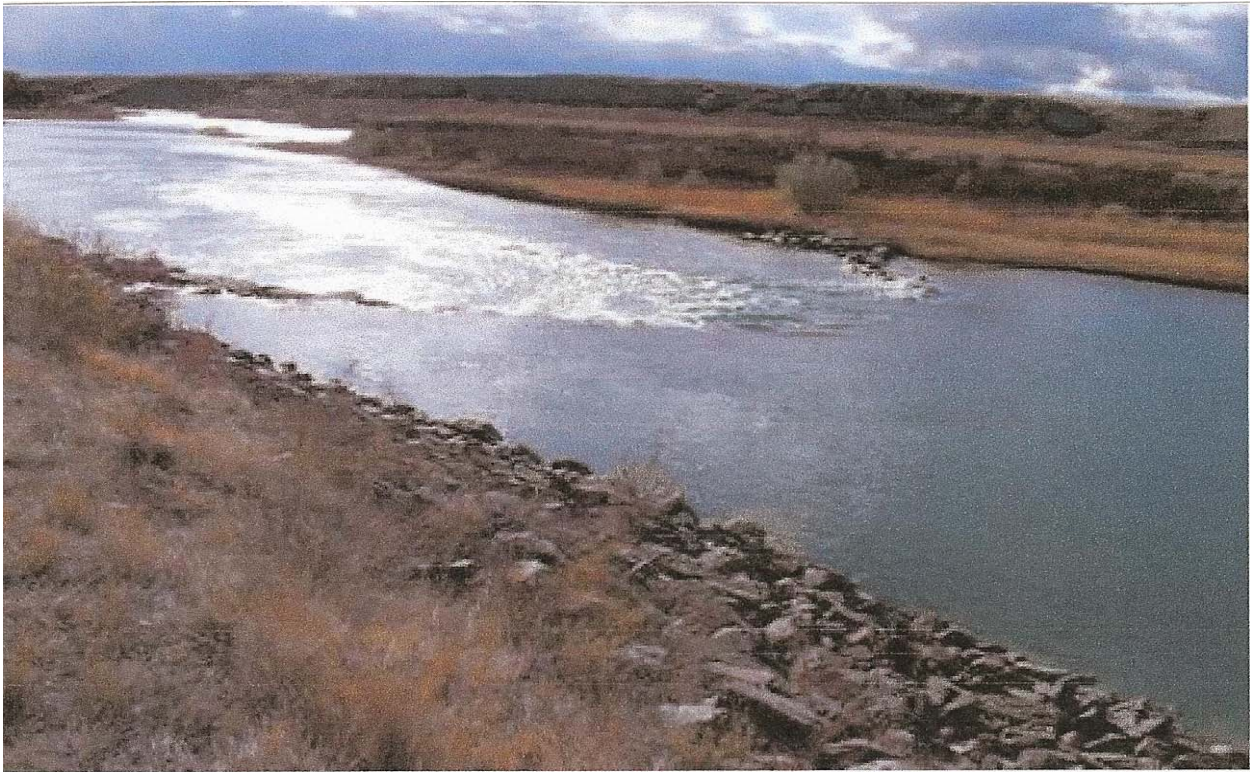

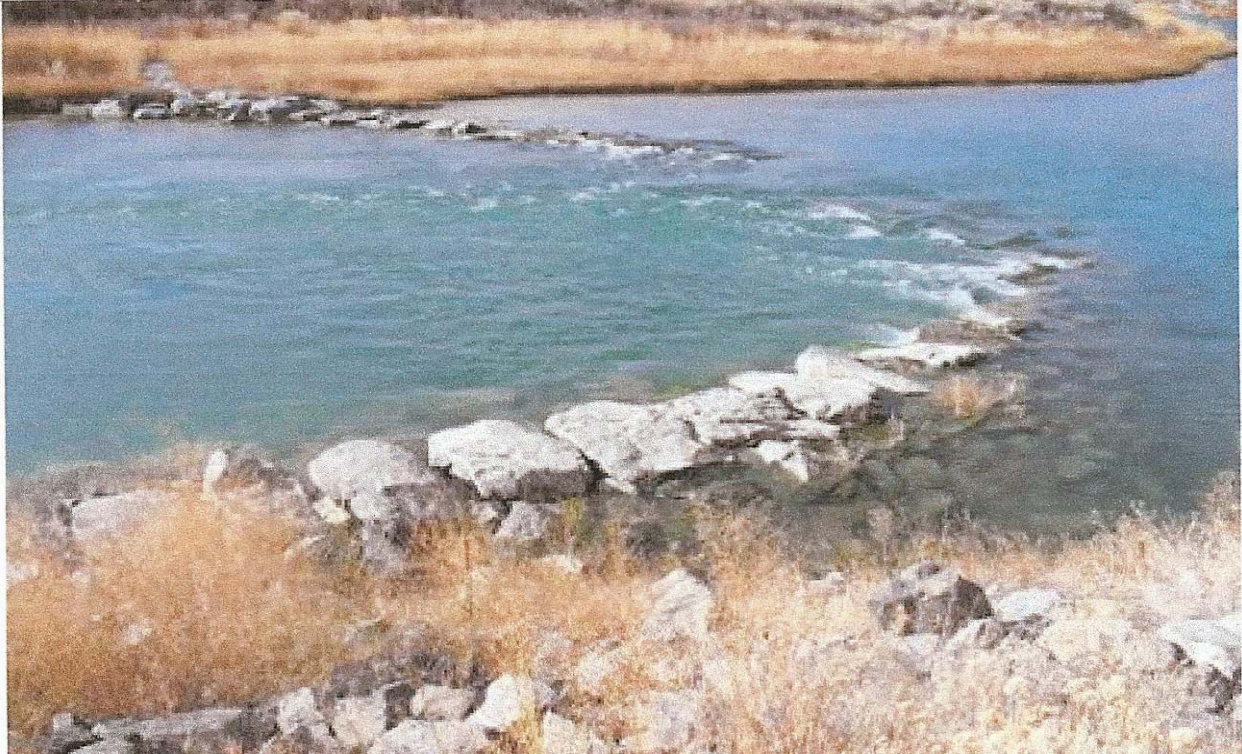

Exhibit 11





Re: Mason Dam and a Forest Service SUA

Michael Gerdes to: jyencopal, Kenneth.Hogan, Mike Hall

06/01/2010 10:02 AM

From: Michael Gerdes <mgerdes@fs.fed.us>

To: jyencopal@bakercounty.org, Kenneth.Hogan@ferc.gov, Mike Hall <mhall02@fs.fed.us>

Morning. At our meeting on May 20, 2010 we had a short discussion regarding the need for a USDA Forest Service (FS) special use authorization (SUA). I initially indicated that a SUA was not required. I have since checked into the regulations/policies and have found that a FS SUA is required for the project.

The Energy Policy Act of October 24, 1992 amended the Federal Land Policy and Management Act of October 21, 1976 and specified that a SUA is not required for any existing project, whether licensed or granted and exemption that was not subject to a permit under the FLPMA prior to October 24, 1992. However, a SUA is required for all NEW hydro project proposed after October 24, 1992. As Mason Dam is a new project it will be required to obtain a SUA from the FS.

In the licensing process, when Baker County submits the license application to the Commission, the FS would expect the SUA application be submitted the FS. Just what you wanted to hear, more process. Jason, we can meet with you and go over the application and process. When we next meet, let's set aside additional time to discuss the SUA. mg

Mike Gerdes
USDA Forest Service - PNW
541.416.6521
mgerdes@fs.fed.us



Work Session Agenda

Jason Yencopal to: Audie Huber, Carolyn Templeton, Carl Stiff, Colleen Fagan, GRIFFIN Dennis, Emily Carter, Fred Warner, Gary Miller, Ken
05/18/2010 05:03 PM
Cc: Heidi Martin, Jason Yencopal

From: Jason Yencopal/Baker County
To: "Audie Huber" <Audiehuber@ctuir.com>, "Carolyn Templeton" <Carolyn.Templeton@ferc.gov>, "Carl Stiff" <cbstiff@wildblue.net>, "Colleen Fagan" <Colleen.E.Fagan@state.or.us>, "GRIFFIN Dennis" <Dennis.Griffin@state.or.us>, "Emily
Cc: Heidi Martin/Baker County@Baker County, Jason Yencopal/Baker County@Baker County

Stakeholders,

Attached is an agenda for the 20th. I originally had the meeting start at 9:00 but hope changing to 10:00 will work for you all. Those attending in person please note that the location is at 2610 Grove St.

Thank you,
Jason



May 20 2010 Work Session Agenda.docx

Work Session

Agenda

May 20, 2010

10:00 – 12 or 1

Location

2610 Grove St.

(Green building, Old Extension Service Building,
New Baker County Weed Dept.)

Conference Call Number

1-877-732-0221

Meeting Room Number

8204693

(Include the star button at the beginning and end)

Welcome

Introductions

Discussion Items

Transmission Line

Dissolved Oxygen

Standards

Compliance Point

ODEQ

Phased DO Plan

Draft Tube Aeration

Bypass Flow

Rock Weirs

Fish Screen

History of the screen proposal

Reasons for changes

Study Discussion

PLP & DBA Comments

Conclusion



Weir Aeration Study

DEVITO Paul to: jyencopal
Cc: "DEVITO Paul"

04/23/2010 03:11 PM

From: "DEVITO Paul" <DEVITO.Paul@deq.state.or.us>
To: <jyencopal@bakercounty.org>
Cc: "DEVITO Paul" <paul.devito@state.or.us>

Jason,

As discussed, here's a study report that examined different weir geometries, plunge depths, discharge quantities, and drop heights on weir aeration efficiencies. This may be helpful design considerations for the County.

Thanks, Paul <<Weir Aeration Efficiency Study.pdf>>

Paul A. DeVito, MSCE

Environmental Engineer

Oregon Department of Environmental Quality

475 NE Bellevue, Suite 110
Bend, Oregon 97701
Phone: 541-633-2029
Toll Free in Oregon: 866-863-6668

FAX: 541-388-8283



Please consider the environment before printing this email. [Weir Aeration Efficiency Study.pdf](#)

Study of Aeration Efficiency at Weirs

Ahmet BAYLAR

Fırat University, Civil Engineering Department, Elazığ-TURKEY

Tamer BAĞATUR

Fırat University, Environmental Engineering Department, Elazığ-TURKEY

Received 17.09.1999

Abstract

The amount of dissolved oxygen (DO) in the waters of rivers and streams is very important to the quality and existence of aquatic life. Hydraulic structures have an impact on the amount of dissolved oxygen in a river system, even though the water is in contact with the structure for only a short time. The same quantity of oxygen transfer that normally would occur over several kilometers in a river can occur at a single hydraulic structure. The primary reason for this accelerated oxygen transfer is that air is entrained into the flow, which produces a large number of bubbles. These air bubbles greatly increase the surface area available for mass transfer. Plunging overfall jets from weirs are a particular instance of this, and the aeration properties of such structures have been studied widely in the laboratory and field over a number of years. This study investigates weirs having different cross-sectional geometry and how they affect the aeration performance. It is demonstrated that the aeration efficiency of the triangular notch weir is generally better than the other weirs.

Key Words: Oxygen transfer, Dissolved oxygen, Aeration, Aeration efficiency, Weirs

Savaklarda Havalandırma Veriminin İncelenmesi

Özet

Nehir ve akarsulardaki çözülmüş oksijen miktarı, hem suyun kalitesini gösteren bir özellik olarak hem de suda yaşayan canlıların yaşamlarını devam ettirebilmeleri için gereken çok önemli bir kriterdir. Hidrolik yapılar, akan su ile kısa bir süre için temasta olmalarına rağmen, bir nehir sistemindeki çözülmüş oksijen miktarı üzerinde önemli bir etkiye sahiptirler. Bir nehirde doğal olarak birkaç kilometrede meydana gelebilecek oksijen transferi, tek bir hidrolik yapı ile hızlı bir şekilde meydana getirilebilir. Bu hızlandırılmış oksijen transferinin asıl sebebi, çok miktarda kabarcık meydana getirerek akım içerisine havanın sokulmasıdır. Bu hava kabarcıkları, kütle transferi için mevcut yüzey alanını çok miktarda artırır. Savaklardan serbest düşen jetler, bunun özel bir örneğidir ve birkaç yıldır laboratuvar ve arazide geniş bir şekilde incelenmektedir. Bu çalışmada farklı enkesit geometrilerine sahip savaklar ve bunların, havalandırma verimini nasıl etkiledikleri incelenmiştir. Çalışmanın sonucunda üçgen enkesite sahip savakların diğer enkesitli savaklardan daha iyi havalandırma verimine sahip olduğu tespit edilmiştir.

Anahtar Sözcükler: Oksijen transferi, Çözülmüş oksijen, Havalandırma, Havalandırma verimi, Savaklar

Introduction

Currently there is much emphasis placed on water quality and maintaining water quality parameters in our freshwater hydrosphere (rivers, lakes, and reservoirs). One of the most widely cited parameters is that of dissolved oxygen (DO) concentration. DO is often used as an indicator of the quality of water used by humans or serving as a habitat for aquatic flora and fauna. It is maintained by many natural chemical and biological processes that either increase or decrease local oxygen concentrations. Respiration by aquatic life serves to reduce DO, as does biodegradation of organic material in the sediments, along with a host of the other oxygen-consuming chemical reactions. Photosynthesis by aquatic plant life can be a significant source of oxygen to a water body, as can oxygen transfer with the atmosphere.

Weir aeration occurs in rivers, fish hatcheries, and water treatment plants. Often, the hydraulic head is naturally available and incurs no operating cost. In some cases, however, weir aeration is economically competitive with alternative aeration technology such as surface aeration, even when energy costs for pumping the water are included.

Before breaking up into drops, the flow over a weir or waterfall would be classified as a free jet as shown in Fig. 1. Typically, most of the oxygen transfer is accomplished in this type of structure during the breakup of the jet, and the free jet's subsequent collision with the bottom of the channel. If the free jet plunges into a downstream water pool, air entrainment and turbulent mixing will contribute to oxygen transfer. Furthermore, the depth

of the downstream water pool can enhance the absorption because of the increased hydrostatic pressure on the entrainment air bubbles. Avery and Novak (1978) found that the transfer efficiency is maximum at a tailwater depth of approximate 0.6 times the drop height, indicating that a trade-off exists between bubble residence time, pressure, and turbulence levels. Oxygen absorption efficiencies vary widely, but for low-head overflow weirs, efficiencies of up to 70 % have been measured.

Gameson (1957) was the first to report on the aeration potential of weirs in rivers. Since then a number of laboratory investigations into weir aeration have been carried out, notably by Van der Kroon (1969a, b), Apted and Novak (1973), Avery and Novak (1978), and Nakasone (1987). Investigations also have been reported on the aeration performance of existing hydraulic structures and these are reviewed by Wilhelms et al. (1992). Gulliver and Rindels (1993), in particular, discuss problems associated with field measurements of oxygen transfer and the degree of uncertainty involved. Much of this work has dealt with straight weirs and free overfalls, among other structures, and none has concentrated specifically on the aeration performance of different shaped weirs.

This paper describes an experimental investigation into the performance of sharp-crested weirs (Fig. 2), and in particular, the effect of varying the shape of the weir. The shape of the weir dictates the behavior of the jet. This in turn is believed to alter the air entrainment and contact time in both the jet itself and the downstream water pool and hence the aeration performance of the weir as a whole.

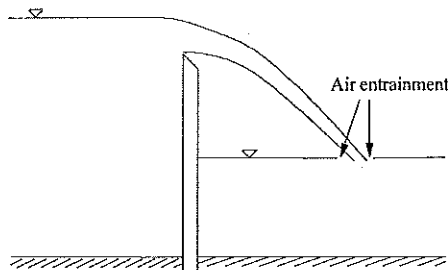

Figure 1. Free Jet over Weir

Background

Oxygen is a highly volatile compound with a gas-water transfer rate that is controlled entirely by the liquid phase. Thus, the change in oxygen concentra-

tion over time in a parcel of water as the parcel travels through a hydraulic structure can be expressed as

$$\frac{dC}{dt} = K_L \frac{A}{V} (C_s - C) \quad (1)$$

where C = dissolved oxygen concentration; K_L = liquid film coefficient for oxygen; A = surface area associated with the volume V , over which transfer occurs; C_s = saturation concentration, or the dissolved oxygen concentration at which equilibrium with the gas phase is achieved; and t = time. The term A/V

is often called the specific surface area, a , or surface area per unit volume. Eq. (1) does not consider sources and sinks of oxygen in the water body because their rates are relatively slow compared to the oxygen transfer that occurs at most hydraulic structures due to the increase in free-surface turbulence and the large quantity of air that is normally entrained into the flow.

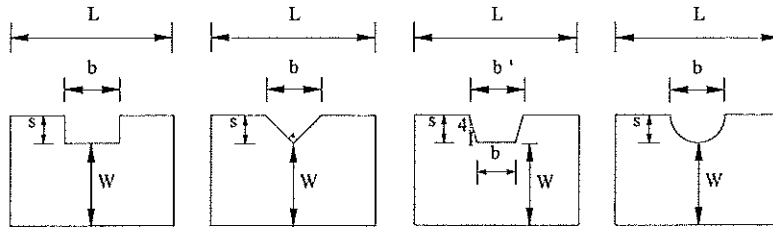

Figure 2. Weir Types Used for Experiments

The predictive relations described herein all assume that C_s is constant and determined by the water-atmosphere partitioning. If that assumption is made, C_s is constant with respect to time, and (1) can be integrated in a moving coordinate system to result in an oxygen transfer efficiency, E (Gulliver et al., 1990).

$$E = \frac{C_d - C_u}{C_s - C_u} = 1 - \frac{1}{r} \quad (2)$$

where subscripts u and d = upstream and downstream locations, respectively and r = oxygen deficit ratio. A transfer efficiency value of 1.0 means that the full transfer up to the saturation value has occurred at the structure. No transfer would correspond to $E = 0.0$. The saturation concentration is normally assumed to be known from charts or equations, and is typically chosen at the local atmosphere value. This is not always the proper choice because the saturation DO concentration for natural waters is often different from that of distilled, deionized water due to the salinity effects.

In this study, the saturation concentrations were determined by the chart of McGhee (1991). The salinity effect would be insignificant because the salt content of tap water used for the experiments was consequently low.

Factors Affecting Aeration Efficiency

The oxygen transfer that occurs at a given structure is sensitive to water temperature, water quality, tailwater depth, drop height, weir discharge, and

dissolved-oxygen deficit.

Water Temperature

Oxygen transfer efficiency is sensitive to water temperature, and investigators have typically employed a temperature correction factor. For hydraulic structures, the most often used temperature correction factor has been that of Gameson et al. (1958), although some investigators have chosen to use an Arrhenius-type of water temperature correction (Holler 1970). Gulliver et al. (1990) applied the theories of Levich (1962), Hinze (1955), and Azbel (1981) to mass transfer similitude and developed the relationship

$$1 - E_{20} = (1 - E)^{1/f} \quad (3)$$

where E = transfer efficiency at the water temperature of measurement and E_{20} = transfer efficiency at the 20°C. The exponent, f , was found to be described by

$$f = 1.0 + 0.02103(T - 20) + 8.261 \times 10^{-5}(T - 20)^2 \quad (4)$$

Water Quality

The presence of surface active agents, organic substances, and suspended solids in water have all been observed to affect the aeration process. Surface active agents in particular appear to modify the process by reducing surface tension, forming diffusion inhibiting films at the air-water interface, and affecting

the hydrodynamic characteristics of the flow. The effect of water quality often is generalized by the use of a "water quality factor" in equations for the deficit ratio, for instance in Gameson (1957) and Markofsky and Kobus (1978). Avery and Novak (1978) used a similar constant to allow for the affects of different concentrations of sodium nitrate in water.

Tap water was used for all of the experiments reported in this paper. Salt content was consequently low and was monitored constantly during the experiments to prevent any buildup of residues caused by the deoxydant chemicals added to the water. Therefore, the presence of chemicals or pollutants did not affect the results.

Tailwater Depth

The residence time of entrained air bubbles in a water body directly affects the oxygen mass transfer. The residence time is related to the bubble flow path and hence the bubble penetration depth into the downstream water pool. Tailwater depth would be an important factor with regard to weir aeration and aeration efficiency would increase with increasing tailwater depth. There should be a limit, however, because the penetrating air bubbles will not go to infinite depths. Actually, for each combination of discharge and fall height, there would be an approximate maximum depth to which the bubbles would penetrate, thus limiting the aeration efficiency and possibly even defining its maximum value. Avery and Novak (1978) found that the tailwater depth of weirs should be approximate 0.6 times the drop height. They indicated that the aeration efficiency remained stable for tailwater depths greater than 0.6h. For consistency, all tests reported in this paper were carried out under these conditions. In all of the experiments at all four weir types the writers determined that air bubbles did not generally reach the floor of the downstream water pool.

Drop Height

The oxygen transfer that occurs at weirs is sensitive to drop height across the structure. Initially, water jets with relatively smooth surfaces issue from the weir and entrain air mainly at the surface of the downstream water pool. As the drop height increases, the surface of the jets first becomes roughened and then the jet oscillates during the fall, entraining air. This results in greater air flow into the downstream water pool. With increasing drop

height, the jet eventually breaks up into discrete droplets and air entrainment prevails. The breakup of the jet reduces its penetration depth into the pool and hence also the depth of the biphasic zone. This effectively reduces contact time t_c between the bubbles and the surrounding water, and so aeration is observed to have little effect. It should be noted that the "breakup length" of the jet (i.e., the difference in level between the weir sill and the point of breakup) is not at all well defined and the jet breaks up over a considerable length. Thus, the change of the jet to discrete droplets is sudden and takes place over a range of drop heights. It does not entail a reduction in aeration efficiency, but a significant decline in the rate of increase in aeration efficiency with drop height.

Weir Discharge

The aeration efficiency for weirs varies with discharge. The aeration efficiency decreases with an increase in discharge. Novak (1973 and 1978) and Van der Kroon (1969a and 1969b) reported a constant increase in the aeration efficiency with decreasing discharge. At low discharges, on the other hand, breakup of the jet is observed as drop height increases. This leads to reduced penetration and bubble contact time into the downstream water pool and so reduced aeration efficiency.

Dissolved-Oxygen Deficit

Oxygen-transfer measurements are typically required at a hydraulic structure to assess the potential for low DO concentrations in the upstream reservoir to continue downstream. For this situation, Murphy's law dictates that the difference between the upstream DO concentration and saturation concentration (the upstream DO deficit) will not be large on the day of the measurement, even though it may be large at other times. From (2) it can be seen that the measurement of transfer efficiency becomes quite sensitive to measurement errors with a low DO deficit upstream. Gulliver and Wilhelms (1992) have stated that an upstream DO deficit of greater than 2.5 mg/L is normally required for any respectable accuracy in an oxygen-transfer efficiency measurement. The primary source of measurement uncertainty was found to be uncertainty in the oxygen-saturation concentration. In summer, when saturation approximates 7 mg/L in most areas, this specification results in an upstream DO of less than 4.5

mg/L. Wilhelms et al. (1992) found that a substantial portion of the oxygen-transfer measurements at hydraulic structures given in the literature suffered from the low upstream deficit problem. They were dropped from the database because an analysis of measurement uncertainty propagation indicated that the uncertainty in these measurements was above a useful value.

DO deficit ratio, $r[(C_s - C_u)/(C_s - C_d)]$ and hence oxygen transfer efficiency E are independent of the upstream DO value C_u . Wormleaton and Soufiani (1998) investigated the independence of oxygen transfer efficiency and upstream DO level. A set of readings was taken of deficit ratio for a model linear weir, with 320 mm sill length, under constant drop height, discharge, tailwater depth, and temperature conditions. The upstream DO concentration C_u was varied over a range from 0 to 80 % of its saturation value and variation in the downstream DO value C_d was noted. The results showed a linear relationship between C_u and C_d . A relationship between C_u and C_d was derived from Eq. (2) as

$$C_d = (1 - E)C_u + EC_s \quad (5)$$

The best-fit line between C_u and C_d was

$$C_d(\%) = 0.289C_u(\%) + 69.53 \quad (6)$$

By comparison with Eq. (5), this gives values for oxygen transfer efficiency E of 0.711 and for C_s of 97.8 %, confirming that the oxygen transfer efficiency is sensibly independent of the upstream DO

deficit. It also reinforces the use of oxygen transfer efficiency as a useful indicator of the aeration behavior of structures.

In this study, to insure that a minimum upstream DO deficit of 2.5 mg/L was maintained, sodium sulfite (Na_2SO_3) was added to the water. Cobalt chloride (CoCl_2) was used as a catalyst.

Experimental Setup

Aeration experiments were conducted using an experimental channel in the Hydraulic Laboratory at the Civil Engineering Department of Fyrat University, Elazığ, Turkey. The experimental channel used in this study was 3.4 m long, 0.60 m wide, and 0.50 m deep with a maximum water flow rate of approximately 4 L/s (Fig. 3). The water jet from the test weir plunged into a downstream water pool, whose height could be adjusted using a pulley arrangement. The water depth in the downstream water pool was controlled by an adjustable weir. The plan-view dimensions of the downstream water pool were 0.6 × 0.6 m. The system included a 3 m³ storage tank.

The test weir featured four exchangeable weir elements: rectangular weir, triangular notch weir, trapezoidal (Cipolletti) weir, and semi-circular weir, as shown in Fig. 2.

Each experiment was started by filling the storage tank with clean water. Sodium sulfite and cobalt chloride were added to the water to increase the upstream DO deficit ($C_s - C_u$) to $\approx \times 2.5$ mg/L.

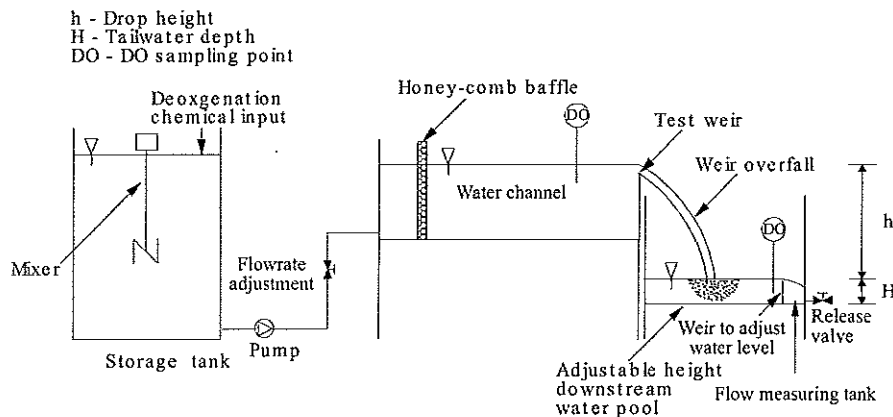

Figure 3. Laboratory Weir Aeration Apparatus

During the experiments, dissolved oxygen and temperature measurements upstream and downstream of the weir were taken using a calibrated portable HANNA Model HI 9142 oxygen meter at the locations identified in Fig. 3. The stirrer was necessary to obtain accurate and reproducible water-phase measurements. The DO meter was calibrated daily, prior to use, by the air calibration method. Calibration procedures followed those recommended by the manufacturer. The calibration was performed in humid air under ambient conditions.

Experimental Program

The dimensions of the weirs tested are given Table 1. Each weir configuration was tested under flow rates Q varying from approximately 1.0 to 4.0 L/s. The drop height h , defined as the difference between the water levels upstream and downstream of the weir, was varied between 0.15 and 0.90 m. The depth in the downstream water pool was maintained throughout at greater than the bubble penetration depth to ensure optimum aeration conditions.

Table 1. Experimental Program and Details

Weir Type	L (cm)	b (cm)	s (cm)	W (cm)
Rectangular weir	60	20	10	40
Triangular notch weir	60	20	10	40
Trapezoidal (Cipolletti) weir	60	15 ($b'=20$)	10	40
Semi-circular weir	60	20	10	40

Results

An experimental run consisted of establishing target values for Q , h , and H within the experimental channel followed by measurement of T , C_u , and C_d . Experimental values of E_{20} were calculated from measured values using (2) and (3).

The following sections discuss the oxygen transfer efficiency (E_{20}) results, which vary with drop height (h), and discharge (Q) (Fig. 4).

Experiments with all four weir types indicate that the drop height is the most important factor influencing aeration efficiency. Fig. 4 shows the oxygen transfer efficiency observed during experiments as a function of drop height and discharge for four different weir types. Fig. 5 also shows variation in aeration efficiency of four different weir types with drop height while the change in discharge is constant. All of these graphs show an increase in aeration efficiency with drop height. Generally, a greater drop height leads to greater bubble penetration depths into the downstream water pool and longer contact times t_c . This increases aeration efficiency. On the other hand, breakup of the jet was observed as the drop height

increased more than 90 cm. Because the jet eventually breaks up into discrete droplets, bubble penetration depth and contact times t_c decrease and hence aeration efficiency decreases.

The results of experiments involving changing weir discharge were far less explicit than those involving drop height. Fig. 4 shows that weir discharge influencing oxygen uptake seems to be closely related to the cross-sectional weir geometry. The aeration efficiency of the triangular notch weir was reduced as the discharge increased over the whole range of drop heights tested. In the other weirs the aeration efficiency was generally greatest at a discharge of 1 L/s and the lowest values of the aeration efficiency were observed at different discharge values. At all four weir types, for the lower discharge, breakup of the jet was observed as the drop height increased. This decreases aeration efficiency.

The rectangular weir produced the lowest values of oxygen transfer efficiency. The greatest rectangular weir oxygen transfer efficiency was 0.37, at a discharge of 1 L/s, and drop height of 0.90 m. The rectangular weir was found to have a poor performance as an aerator.

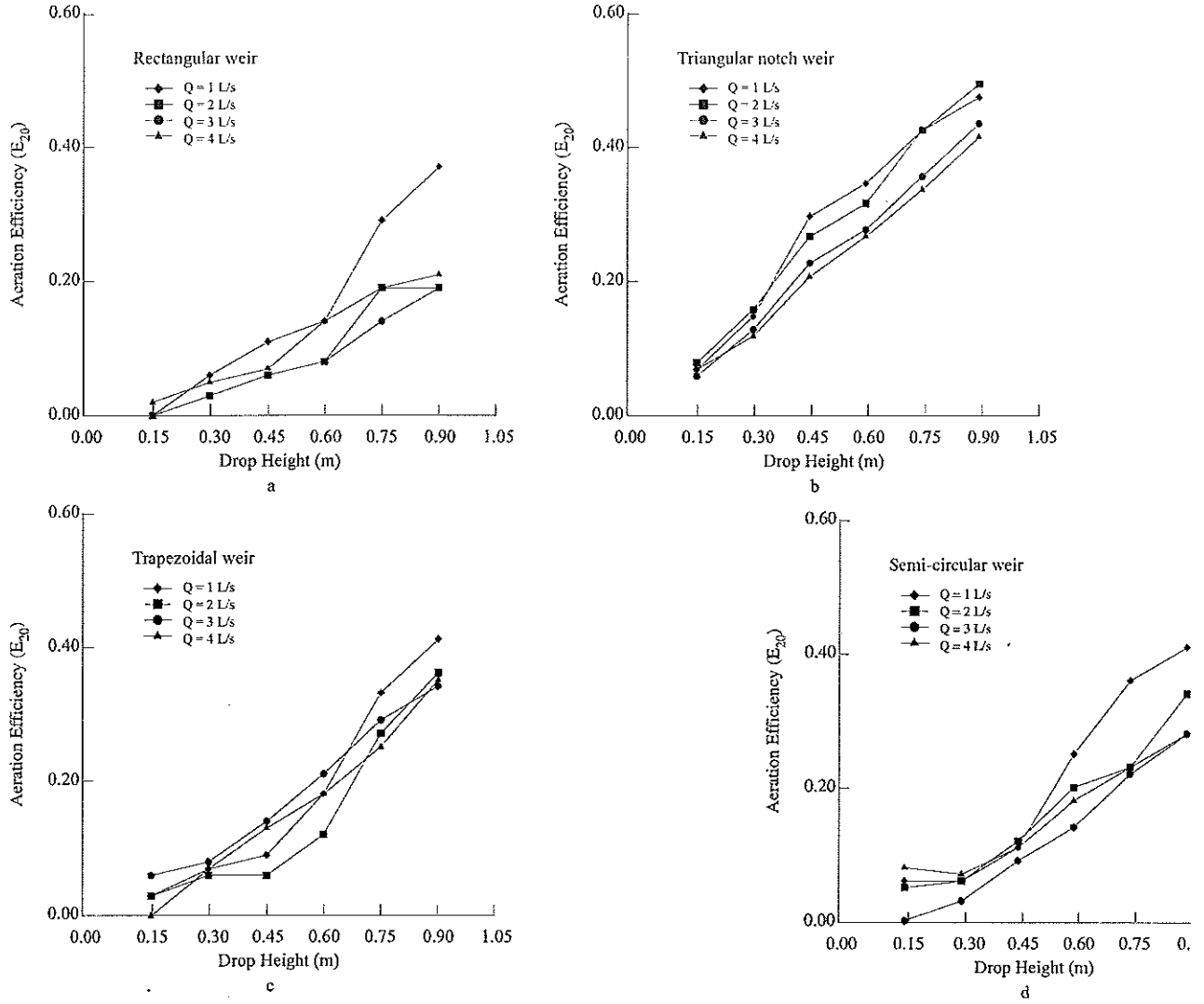

Figure 4. Variation in Aeration Efficiency with Drop Height and Discharge for (a) Rectangular Weir; (b) Triangular Notch Weir; (c) Trapezoidal (Cipolletti) Weir; (d) Semi-Circular Weir

For the trapezoidal weir, the values of oxygen transfer efficiency were in general agreement with the values of the semi-circular weir. The greatest trapezoidal weir and semi circular weir oxygen transfer efficiency was 0.41, at a discharge of 1 L/s, and drop height of 0.90 m.

The triangular notch weir was found to have the greatest values of oxygen transfer efficiency. The greatest triangular notch weir oxygen transfer efficiency was 0.50, at a discharge of 2 L/s, and drop

height of 0.90 m and 0.48, at a discharge of 1 L/s, and drop height of 0.90 m. Aeration efficiency was greatest with the triangular notch weir because in this weir air entrainment and turbulent mixing which will contribute to the oxygen transfer were greater than in the other weirs. The primary reason for this difference may be jet shapes. The weir geometry defines jet shapes that are unique to each weir, and the oxygen transfer seems to strongly depend on these jet shapes.

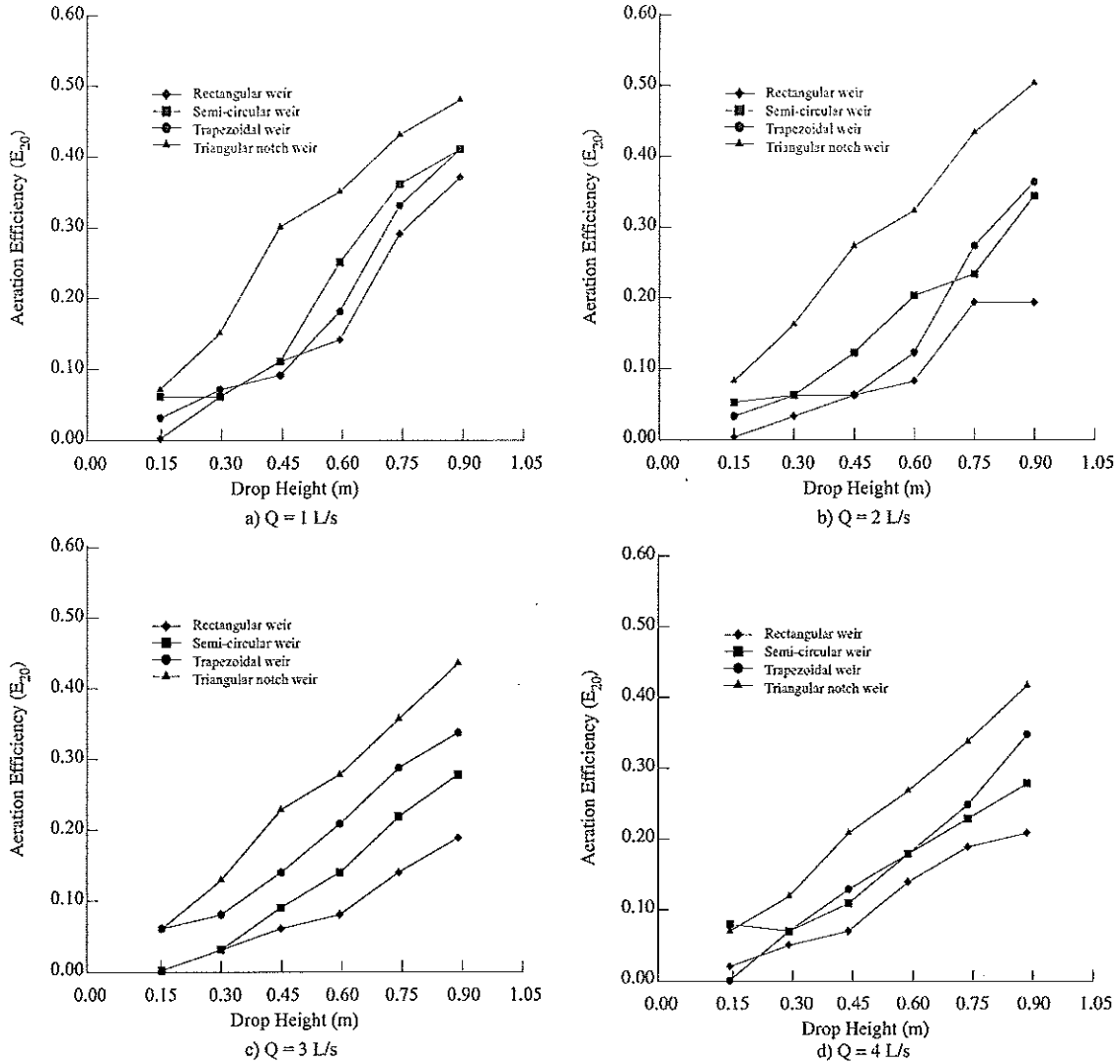

Figure 5. Variation in Aeration Efficiency of All Four Weir Types with Drop Height for (a) $Q=1 \text{ L/s}$; (b) $Q=2 \text{ L/s}$; (c) $Q=3 \text{ L/s}$; (d) $Q=4 \text{ L/s}$

Conclusions

A series of laboratory experiments were carried out to measure the aeration performance of different shaped weirs over a range of flows between 1 and 4 L/s with drop heights from 0.15 - 0.90 m. The total weir length was kept constant at 0.60 m. The following conclusions may be drawn about weirs.

- The drop height was confirmed to be the most important parameter influencing oxygen transfer at weirs. The aeration efficiency increased

with drop height in all cases.

- The results of experiments involving changing weir discharge were far less explicit than those involving drop height. The aeration efficiency of the triangular notch weir was reduced as the discharge increased over the whole range of drop heights tested. In the other weirs the aeration efficiency was generally greatest at a discharge of 1 L/s and the lowest values of the aeration efficiency were observed at different

discharge values.

- At all four weir types, for the lower discharge, breakup of the jet was observed as the drop height increased. This decreases aeration efficiency.
- The weir shape was found to be an important factor influencing the aeration efficiency. The weir geometry defines jet shapes that are unique to each weir, and the oxygen transfer seems to strongly depend on these jet shapes.
- The experimental values of the trapezoidal weir for the oxygen transfer efficiency (E_{20}) are in general agreement with the results of the semi-circular weir experimental values.
- The oxygen transfer efficiency was greatest with the triangular notch weir and lowest with the rectangular weir. The rectangular weir generally would not therefore be recommended.
- Tailwater depth as well as drop height and discharge is important for weir aeration. Therefore, there should be a tailwater depth that air bubbles will penetrate to an approximate maximum depth.

Acknowledgements

The financial support of this work was provided

by Firat University Research Fund (FÜNAP).

Symbols

a	:	the specific surface area (A/V), or surface area per unit volume
A	:	surface area associated with the volume V , over which transfer occurs
b	:	crest width of weir
C	:	dissolved oxygen concentration
C_d	:	dissolved oxygen concentration downstream of a hydraulic structure
C_s	:	saturation concentration
C_u	:	dissolved oxygen concentration upstream of a hydraulic structure
E	:	transfer efficiency at the water temperature of measurement
E_{20}	:	transfer efficiency at the 20°C
f	:	term to adjust from 20°C to T°C
h	:	drop height
H	:	tailwater depth
K_L	:	liquid film coefficient for oxygen
L	:	the experimental channel width
Q	:	weir discharge
r	:	oxygen deficit ratio
s	:	difference between crest and top of weir
t	:	time
T	:	water temperature
W	:	difference between base and crest of weir

References

- Apted, R. W., and Novak, P., "Some Studies of Oxygen Uptake at Weirs", Proceedings of the XV Congress, IAHR paper B23, 1973.
- Avery, S., and Novak, P., "Oxygen Transfer at Hydraulic Structures", Journal of Hydraulic Engineering, ASCE, Vol. 104, HY11, pp. 1521-1540, 1978.
- Azbel, D., "Two Phase Flows in Chemical Engineering", Cambridge Univ. Press, Cambridge, England, 1981.
- Gameson, A. L. H., "Weirs and Aeration of Rivers", Journal of the Institution of Water Engineers, Vol. 11, 1957.
- Gameson, A. L. H., Vandyke, K. G., and Ogden, C. G., "The Effect of Temperature on Aeration", Water and Water Engineering, November, 1958.
- Gulliver, J. S., and Wilhelms, S. C., "Discussion of 'Aeration at Ohio River Basin Navigation Dams,' by S. F. Railsback, J. M. Bownds, M. J. Sak, M. M. Stevens, and G. H. Taylor", Journal of Environmental Engineering, ASCE, Vol. 108, No. 3, March, pp. 444-446, 1992.
- Gulliver, J. S., and Wilhelms, S. C., and Parkhill, K. L., "Predictive Capabilities in Oxygen Transfer at Hydraulics Structures", Journal of Hydraulic Engineering, ASCE, Vol. 124, No. 7, July, pp. 664-671, 1998.
- Gulliver, J. S., and Rindels, A. J., "Measurement of Air-Water Oxygen Transfer at Hydraulics Structures", Journal of Hydraulic Engineering, ASCE, Vol. 119, No. 3, March, pp. 328-349, 1993.
- Gulliver, J. S., Thene, J. R., and Rindels, A. J., "Indexing Gas Transfer in Self-Aerated Flows", Journal of Environmental Engineering, ASCE, Vol. 116, No. 3, March, pp. 503-523, 1990.
- Hinze, J. O., "Fundamentals of the Hydrodynamic Mechanism of Splitting in Dispersion Processes",

- Am. Inst. of Chem. Engrg. J., 1 (3), pp. 289-295, 1955.
- Holler, A. G., "Reaeration of Discharge through Hydraulic Structures", PhD Thesis, University of Cincinnati, Cincinnati, Ohio, 1970.
- Levich, V. G., "Physicochemical Hydrodynamics", Prentice-Hall, Englewood Cliffs, N. J., 1962.
- Labocha, M., Corsi, R. L., and Zytner, R. G., "Parameters Influencing Oxygen Uptake at Clarifier Weirs", Water Environmental Research, Vol. 68, No. 6, September/October, pp. 988-994, 1996.
- Markofsky, M., and Kobus H., "Unified Presentation of Weir-Aeration Data", Journal of Hydraulic Engineering, ASCE, Vol. 104, pp. 562, 1978.
- McGhee, T. J., "Water Supply and Sewerage", McGRAW - HILL International Editions, 6th Edition, 1991.
- Nakasone, H., "Study of Aeration at Weirs and Cascades", Journal of Environmental Engineering, ASCE, Vol. 113, No. 1, February, pp. 64-81, 1987.
- Van der Kroon, G. T. N., and Schram, A. H., "Weir Aeration - Part I", H2O, No.22, pp.528-537, 1969a.
- Van der Kroon, G. T. N., and Schram, A. H., "Weir Aeration - Part II", H2O, No.22, pp.538-545, 1969b.
- Watson, C.C., Walters, R. W., and Hogan, S. A., "Aeration Performance of Low Drop Weirs", Journal of Hydraulic Engineering, ASCE, Vol. 124, No. 1, January, pp. 65-71, 1998.
- Wilhelms, S. C., Gulliver, J. S., and Parkhill, K., "Reaeration at Low-Head Hydraulic Structures", Tech. Rep. HL-91, U. S. Army Engineer Waterways Experiment Station, Vicksburg, Miss, 1992.
- Wormleaton, P. R., and Soufiani, E., "Aeration Performance of Triangular Planform Labyrinth Weirs", Journal of Environmental Engineering, ASCE, Vol. 124, No. 8, pp. 709-719, 1998.



Re: Archaeological Questions

Mike Hall to: jyencopal

04/16/2010 09:08 AM

From: Mike Hall <mhall02@fs.fed.us>
To: jyencopal@bakercounty.org

Jason:

I checked with our Archeologist and he said that the revised report is now acceptable . He also consulted SHPO and their only concern is they felt the APE may not cover the whole project area . Erik said that as long as all project activity stays within the APE as defined in the report you are good to go .

Mike

Michael A. Hall
Recreation, Lands and Minerals RDMA
Whitman District, Wallowa-Whitman NF
phone: 541-523-1294
fax: 541-523-1965
cell: 541-519-5187
email; mhall02@fs.fed.us

jyencopal@bakercounty.org

04/12/2010 09:52 AM

To Mike Hall <mhall02@fs.fed.us>
cc
Subject Archaeological Questions

Mike,

I have been going through the comments received for the PLP and DBA and was working on the questions specifically about the Archaeological Survey Report. I did provide those questions and comments to Katie who revised her report and is titled/dated " Archaeological Survey of the Mason Dam Hydroelectric... REVISED March, 2009." She felt she had addressed those questions in that revised report. However, I don't believe Eric had a copy of that report before the comments were submitted. I wanted to check to see if the report was received by Eric. Katie said she dropped it off last month but he was out of the office and did not receive any confirmation that he has received it. If he has received it and had time to review it, did it answer the questions or are there any additional questions on the report?

Thank you,
Jason